

# Reference Manual For Oyster Aquaculturists

Agriculture and Aquaculture

2008



## **ACKNOWLEDGEMENTS**

The Reference Manual for Oyster Aquaculturists was prepared by Sylvio Doiron, a shellfish culture biologist at the Department of Agriculture and Aquaculture. The author wishes to extend a warm thank-you to all those who contributed to the writing of this guide. Without their help, it could not have become a reality.

The author is also grateful to the oyster aquaculturists on whose sites most of the photographs were taken. Their co-operation is always very important and much appreciated.

### **COLLABORATORS**

The following persons collaborated on this project either by sharing their expertise or by providing us with unrestricted access to their sites:

Albertin Albert	Donat Robichaud
Allain Mallet	Léon Lanteigne
Amédée Savoie	Mario Noël
André Mallet	Maurice Daigle
Archie Allain	Neil McNair
Chantal Gionet	Stéphane Mallet
Clair Carver	Zénon Chiasson

All of the photographs of equipment and materials used in oyster aquaculture were taken on the sites of those producers.

Mention should be made of Léon Lanteigne and Maurice Daigle, who, through their tireless development efforts, have rekindled an interest in oyster aquaculture. It is partly because of them that it became necessary to write this manual.

Lastly, the collaboration of André Mallet must not be overlooked. His expertise in aquaculture and genetics was a major asset in the writing of this manual.

**2008 Edition**

## TABLE OF CONTENTS

<b>LIST OF FIGURES .....</b>	<b>V</b>
<b>LIST OF TABLES .....</b>	<b>VII</b>
<b>INTRODUCTION.....</b>	<b>1</b>
<b>OYSTER BIOLOGY .....</b>	<b>2</b>
<b>TERMINOLOGY .....</b>	<b>2</b>
<b>DISTRIBUTION.....</b>	<b>4</b>
<b>ANATOMY .....</b>	<b>5</b>
<b>GROWTH.....</b>	<b>6</b>
<b>REPRODUCTION.....</b>	<b>8</b>
<b>RECRUITMENT .....</b>	<b>9</b>
<b>PREDATORS.....</b>	<b>10</b>
<b>DISEASES AND PARASITES .....</b>	<b>10</b>
<b>FOULING ORGANISMS, COMPETITORS, ETC.....</b>	<b>13</b>
<b>NUTRITIONAL VALUE.....</b>	<b>15</b>
<b>SITE SELECTION .....</b>	<b>16</b>
<b>SURFACE AREA .....</b>	<b>16</b>
<b>CURRENTS.....</b>	<b>16</b>
<b>PREVAILING WINDS.....</b>	<b>16</b>
<b>ACCESSIBILITY .....</b>	<b>16</b>
<b>DEPTH.....</b>	<b>17</b>
<b>RIPARIAN OWNERS AND OTHER USERS.....</b>	<b>17</b>
<b>GROWING AREA CLASSIFICATION .....</b>	<b>18</b>
<i>Approved Growing Areas .....</i>	<i>18</i>
<i>Conditionally Approved Growing Areas.....</i>	<i>18</i>
<i>Closed Growing Areas .....</i>	<i>18</i>
<i>Unclassified Growing Areas .....</i>	<i>19</i>
<b>LEASES AND LICENCES .....</b>	<b>20</b>
<b>SITE MARKING .....</b>	<b>20</b>
<b>SPAT SUPPLY.....</b>	<b>21</b>
<b>SHELLFISH HATCHERY .....</b>	<b>21</b>
<i>Food Production .....</i>	<i>22</i>
<i>Broodstock Conditioning .....</i>	<i>23</i>
<i>Larval Rearing .....</i>	<i>23</i>
<i>Spat Rearing.....</i>	<i>25</i>
<b>COLLECTION IN THE NATURAL ENVIRONMENT.....</b>	<b>26</b>
<i>Collection on Collectors.....</i>	<i>27</i>
<i>Liming of Chinese Hat Collectors .....</i>	<i>27</i>
<i>Collection Yield .....</i>	<i>28</i>
<i>Spat Removal.....</i>	<i>29</i>
<b>REMOTE SETTING .....</b>	<b>30</b>
<b>TRIPLOID OYSTERS .....</b>	<b>31</b>

<b>NURSERY .....</b>	<b>33</b>
<b>FLUPSY.....</b>	<b>33</b>
<b>REARING METHODS .....</b>	<b>36</b>
<b>FLOATING BAGS .....</b>	<b>36</b>
<i>Layout of Longlines .....</i>	<i>37</i>
<i>Anchoring.....</i>	<i>38</i>
<i>Density .....</i>	<i>39</i>
<i>Sorting .....</i>	<i>41</i>
<i>Overwintering.....</i>	<i>44</i>
<i>Yield.....</i>	<i>45</i>
<i>Constraints .....</i>	<i>45</i>
<i>Innovation .....</i>	<i>46</i>
<b>BAGS ON TABLES .....</b>	<b>47</b>
<i>Arrangement of Tables .....</i>	<i>47</i>
<i>Density .....</i>	<i>48</i>
<i>Sorting .....</i>	<i>48</i>
<i>Overwintering.....</i>	<i>48</i>
<i>Yield.....</i>	<i>48</i>
<i>Constraints .....</i>	<i>48</i>
<b>FRENCH LONGLINE (RESEARCH AND DEVELOPMENT) .....</b>	<b>49</b>
<i>Cementing of Oysters .....</i>	<i>50</i>
<i>Setting of Longlines .....</i>	<i>53</i>
<b>HARVESTING.....</b>	<b>55</b>
<b>PROCESSING.....</b>	<b>58</b>
<i>Washing.....</i>	<i>58</i>
<i>Sorting .....</i>	<i>58</i>
<b>DEVELOPMENT OF A SHELLFISH ENTERPRISE .....</b>	<b>62</b>
<b>BUSINESS PLAN .....</b>	<b>62</b>
<b>PRODUCTION PLAN .....</b>	<b>63</b>
<i>Rearing Method .....</i>	<i>63</i>
<i>Use of Space .....</i>	<i>63</i>
<i>Production Cycle.....</i>	<i>64</i>
<i>Workforce.....</i>	<i>66</i>
<i>Equipment .....</i>	<i>66</i>
<b>CONCLUSION .....</b>	<b>67</b>
<b>BIBLIOGRAPHY .....</b>	<b>68</b>
<b>APPENDIX I CONVERSION TO INTERNATIONAL SYSTEM.....</b>	<b>69</b>
<b>APPENDIX II HOW TO OPEN AN OYSTER .....</b>	<b>70</b>
<b>APPENDIX III OVERWINTERING SPECIFICATIONS .....</b>	<b>71</b>
<b>APPENDIX IV EQUIPMENT.....</b>	<b>72</b>

## LIST OF FIGURES

Figure 1 Eastern oyster ( <i>Crassostrea virginica</i> ) .....	2
Figure 2 European oyster ( <i>Ostrea edulis</i> ).....	3
Figure 3 Pacific oyster ( <i>Crassostrea gigas</i> ).....	3
Figure 4 Map of New Brunswick .....	4
Figure 5 Illustration of the two valves of an oyster .....	5
Figure 6 View of the internal parts of an oyster.....	5
Figure 7 Life cycle of the oyster .....	7
Figure 8 Oyster larvae of different sizes .....	9
Figure 9 Oyster spat on a Chinese hat.....	10
Figure 10 Oyster shell bored into by a sponge.....	11
Figure 11 <i>Styela clava</i> (P.E.I.).....	14
Figure 12 <i>Ciona intestinalis</i> (N.S.).....	14
Figure 13 <i>Molgula manhattensis</i> (Tunicate or sea squirt) .....	15
Figure 14 Arrangement of bags on the bottom during the winter.....	17
Figure 15 Algae room.....	22
Figure 16 Larval rearing tank (1,100 litres) in a multifunctional room .....	24
Figure 17 Downweller system used in hatcheries.....	25
Figure 18 Oyster collectors.....	26
Figure 19 Liming tub .....	27
Figure 20 Stripping machine (A – entrance B – exit).....	30
Figure 21 Description of triploidy.....	32
Figure 22 Diagram of a Flupsy - overhead view.....	33
Figure 23 Illustration of a Flupsy .....	34
Figure 24 Samples of two types of construction .....	35
Figure 25 Oyster bag.....	36
Figure 26 Oyster bag longline .....	38
Figure 27 Helical screw anchor and hydraulic device .....	39
Figure 28 Oyster sorting machine (home-made).....	42
Figure 29 Vibrating screen (commercially manufactured).....	43
Figure 30 Diagram of a submerged longline.....	44

<b>Figure 31</b>	<b>Oyster rearing in bags on tables .....</b>	<b>47</b>
<b>Figure 32</b>	<b>Experimental French longline .....</b>	<b>49</b>
<b>Figure 33</b>	<b>Marine fouling organisms .....</b>	<b>50</b>
<b>Figure 34</b>	<b>Cementing support.....</b>	<b>51</b>
<b>Figure 35</b>	<b>Cementing of oysters.....</b>	<b>52</b>
<b>Figure 36</b>	<b>Oysters on strings suspended from rafts .....</b>	<b>53</b>
<b>Figure 37</b>	<b>Experimental longline.....</b>	<b>54</b>
<b>Figure 38</b>	<b>Harvesting through the ice.....</b>	<b>55</b>
<b>Figure 39</b>	<b>Oyster gauge .....</b>	<b>56</b>
<b>Figure 40</b>	<b>Oyster washer.....</b>	<b>57</b>
<b>Figure 41</b>	<b>Grades of oysters.....</b>	<b>59</b>
<b>Figure 42</b>	<b>Workers assigned to oyster sorting and packaging .....</b>	<b>60</b>
<b>Figure 43</b>	<b>End of an oyster grader.....</b>	<b>60</b>
<b>Figure 44</b>	<b>Side view of an oyster grader.....</b>	<b>61</b>
<b>Figure 45</b>	<b>Diagram illustrating the use of an aquaculture lease .....</b>	<b>63</b>

## LIST OF TABLES

<b>TABLE I</b>	<b>Origin of spat and information.....</b>	<b>21</b>
<b>TABLE II</b>	<b>Rearing density and bags required .....</b>	<b>40</b>
<b>TABLE III</b>	<b>Suggested rearing densities .....</b>	<b>41</b>
<b>TABLE IV</b>	<b>Oyster growth under optimum conditions .....</b>	<b>45</b>
<b>TABLE V</b>	<b>Changes in production over the years.....</b>	<b>64</b>
<b>TABLE VI</b>	<b>Production cycle .....</b>	<b>65</b>

# INTRODUCTION

When it comes to the Maritime provinces, the activity that immediately springs to mind is fishing. New Brunswick has a well-established fishery. The harvesting of a number of species of fish and crustaceans generates considerable economic spinoffs along the entire east coast as well as in the Bay of Fundy area. Snow crab, lobster, and herring top the list in terms of monetary value.

Aquaculture has become a major industry in New Brunswick. In 2001, Atlantic salmon production yielded revenues of about \$223 million. Shellfish aquaculture is gaining ground as well. Mussel production exceeds 1,000 metric tons and is expanding rapidly.

Oyster aquaculture had been attracting the interest of oyster producers for several years but was unable to really stand out. Then, the development of a new rearing method changed the industry's profile. Rearing in oyster bags gave a boost to oyster aquaculture on New Brunswick's east coast.

The New Brunswick Department of Agriculture, Fisheries and Aquaculture has always supported the development of this industry. Over time, it became increasingly necessary to write a reference guide for oyster aquaculturists because the *Oysterculturist Manual* (Ferguson, 1984) only partly fulfilled its role of providing information.

This manual is intended for a novice clientele and includes a section on oyster biology. The information presented covers the basics regarding this species. For more detailed information, it would be advisable to consult specialized manuals. This document looks as well at such topics as site selection, rearing methods, spat supply, and production plans.



## OYSTER BIOLOGY

The oyster produced in New Brunswick is the eastern oyster (*Crassostrea virginica* Gmelin), although other species, such as the European oyster (*Ostrea edulis* ) and the Pacific oyster (*Crassostrea gigas*) are reared elsewhere in the world.

### TERMINOLOGY

The only oyster species reared on New Brunswick's east coast is the eastern oyster, also known as the Atlantic oyster. Its scientific name is *Crassostrea virginica* (Gmelin, 1791). The French term for the species is "huître américaine." (Figure 1)



**Figure 1** Eastern oyster (*Crassostrea virginica*)

In the Bay of Fundy, the flat, or European, oyster (*Ostrea edulis*) (Figure 2) has been introduced and shows good potential. However, on the province's east coast, trials have shown that it cannot survive the winter there.



**Figure 2** European oyster (*Ostrea edulis*)

Another well-known species is the Pacific oyster (*Crassostrea gigas*) (Figure 3). It is reared around the world but has never been introduced in New Brunswick.



**Figure 3** Pacific oyster (*Crassostrea gigas*)

## DISTRIBUTION

The eastern oyster is found along the eastern coasts of North and South America. Its range extends from the Gulf of St. Lawrence in Canada to the Gulf of Mexico and also includes the coasts of Brazil and Argentina. This oyster is found mainly in estuaries and coastal regions with reduced salinity.

The eastern oyster is harvested commercially and intensively in all areas where it reproduces naturally. Its habitat varies from soft silty soils to rocky bottoms, and it settles on appropriate substrates in both intertidal and subtidal zones. In New Brunswick, oysters are found all along the province's east coast (Figure 4).

Under optimum conditions, oysters can live for more than 20 years. The species' tolerance limits are vast. The eastern oyster can live in areas where the water temperature ranges between  $-2^{\circ}\text{C}$  and  $36^{\circ}\text{C}$ . It also tolerates wide variations in salinity. Optimum salinity conditions have been determined to range between 14 g/L and 28 g/L, but the eastern oyster survives in more extreme situations where the salinity fluctuates between 1.5 and 39 g/L.

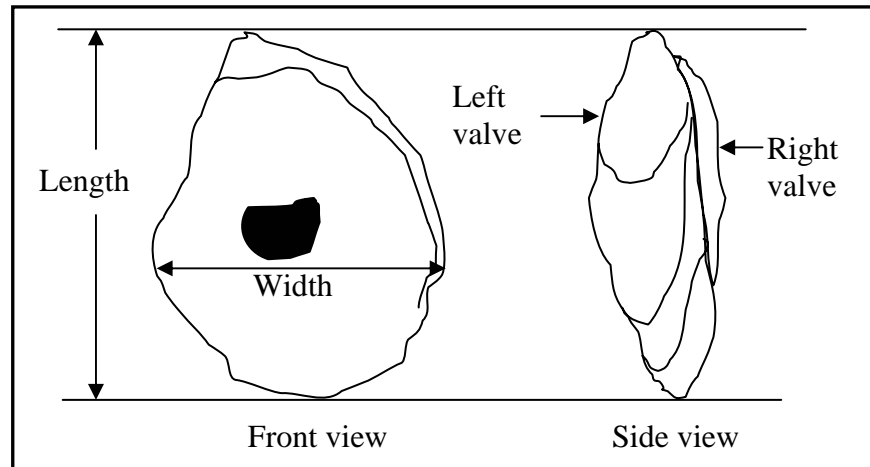

**Figure 4** Map of New Brunswick

In New Brunswick, oysters are present in all the estuaries from Caraquet Bay in the north to Cape Tourmentine (Confederation Bridge) in the south.

## ANATOMY

The eastern oyster is a bivalve mollusc. The meat (soft part) is protected by two asymmetrical valves made of calcareous material (Figure 5) that are twice as heavy as water and about 95% calcium carbonate. Oysters generally lie on the sea bottom on their left valve, which is concave. The top right valve is generally flatter. A tough elastic ligament that enables the valves to open is located on the anterior part. The valves shut forming a water-tight and air-tight seal by means of an adductor muscle that holds them together.



**Figure 5** Illustration of the two valves of an oyster

On the inside is the meat, which is made up of all the oyster's organs (Figure 6).

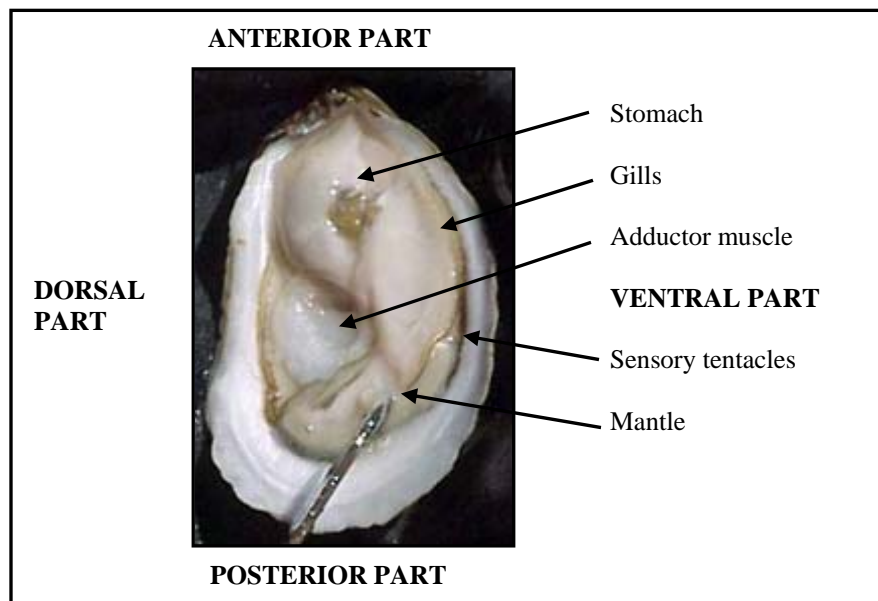

**Figure 6** View of the internal parts of an oyster

## **GROWTH**

Oysters feed by filtering water, which contains its food. Their diet consists of microscopic animals and algae and any suspended material that is small enough to pass through their gills. The food travels through the gills to the palps and then to the mouth thanks to the rhythmic movements of thousands of small hairs found in the gills.

Like any cold-blooded animal, oysters depend on the temperature of the environment to control their metabolism. When submerged at temperatures that suit them, oysters feed continuously. The optimum ingestion rate is achieved at 25°C. An oyster larger than 76 mm can filter between 9 and 13 litres of water per hour. When the water temperature drops below 4°C, oysters stop feeding completely. They can survive for long periods of time without feeding.

The mantle secretes the shell material, which is built up from the inside of the valves. The anterior end where the hinge is located is the oldest part of the oyster. In New Brunswick, oysters can grow from May to September, but most growth takes place in May and June. Oysters that grow naturally on the bottom take four to seven years to reach a size of 76 mm (Figure 7). With the new rearing methods, this period is reduced considerably. Oysters placed in floating bags can grow to 76 mm in less than four years. An oyster's shape is affected by rearing conditions such as density, whereas on the sea bottom, it is controlled mainly by the quality of the substrate.

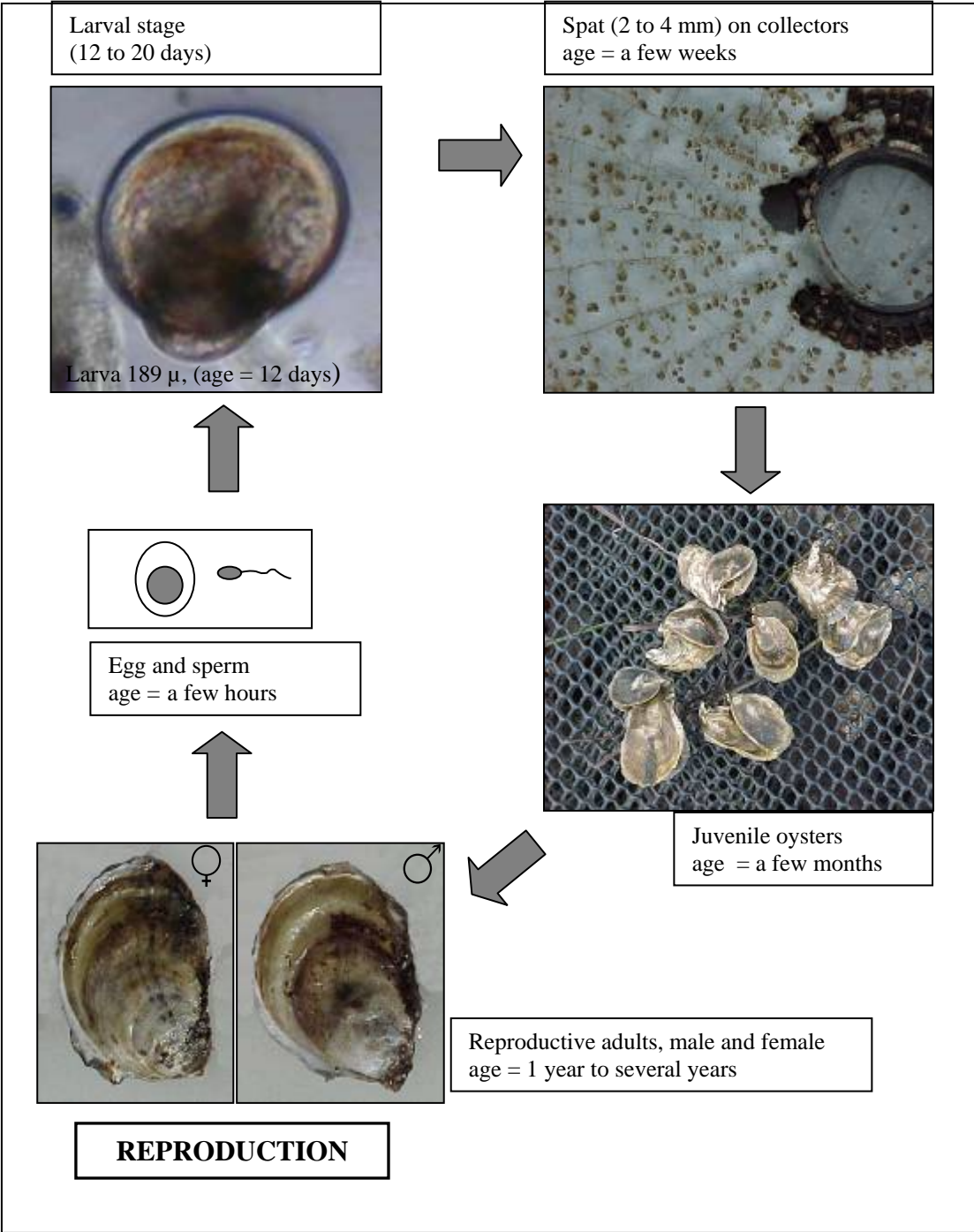

Figure 7 Life cycle of the oyster

## REPRODUCTION

The eastern oyster is a species that undergoes sex reversal. There are male oysters and female oysters, but they change sex every year. After spawning, the oyster enters a period of sexual rest. At that time, the reproductive organs shrink, and it is impossible to determine the animal's sex.

In June, oysters prepare for spawning. They are then said to be "milky" (the meat takes on a whitish appearance). Temperature triggers spawning. Once the water temperature reaches 20°C, the female oysters clap their valves together and release millions of eggs into the marine environment. The males do their part as well, releasing an even greater number of sperm.

Fertilization takes place in the water, and 24 hours later, a larva (Figure 8) capable of free movement travels with the tidal currents. The length of the larval period varies depending on the conditions in the marine environment. If the water temperature remains above 20°C and sufficient quantities of food are available, the larval period lasts for only a few weeks.

When the larva reaches the size of 300 microns, a distinctive black dot can be observed through a microscope. The larva is then said to be "eyed." At that point, it is ready to settle on some sort of substrate. A larva newly attached to a collector/substrate is called a "spat." Spat collection generally takes place in July but can go on until August.

In the fall, the size of the spat will vary depending on the growing conditions on the collector. Oyster spat can grow to a size of more than 15 mm by the fall if they settle on a collector that provides enough growing space.

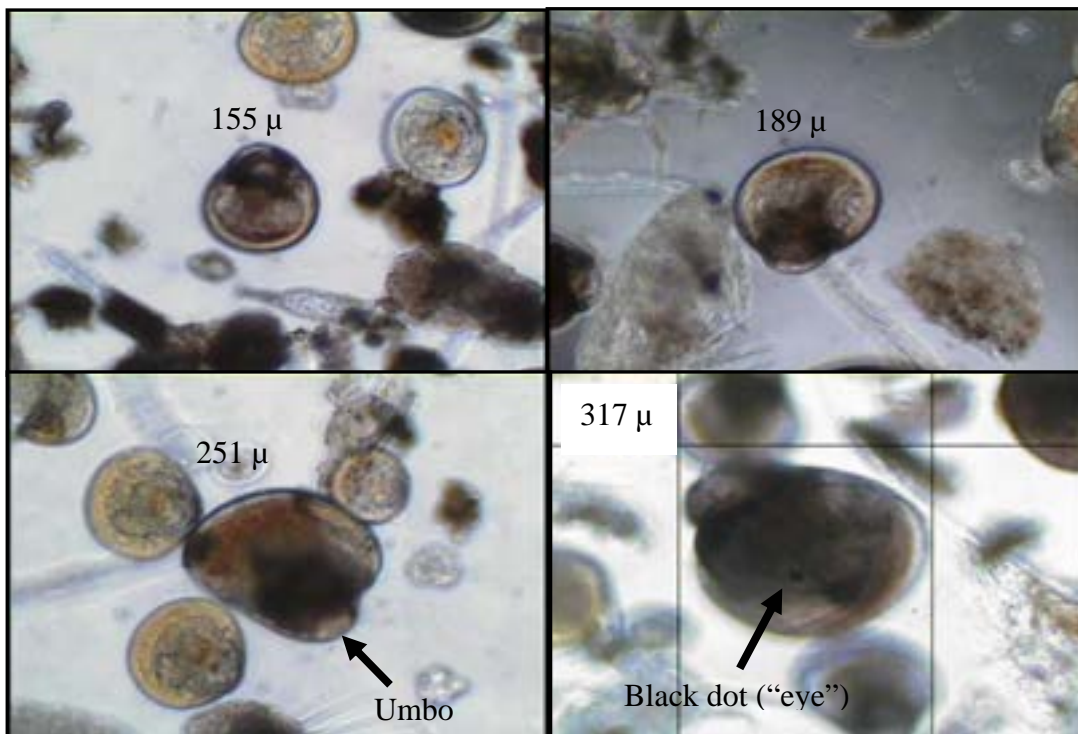

**Figure 8** Oyster larvae of different sizes

The umbo forms at the point where the two valves meet and becomes protuberant early in the larva's development.

## RECRUITMENT

Recruitment in the natural environment is highly variable and depends on many factors. The success of collecting spat on collectors depends largely on the whims of Mother Nature. Major fluctuations in recruitment have been observed in certain bays. For example, in Caraquet Bay, there have been years where the number of larvae was too small to justify the setting of collectors, whereas the following season, the same collectors were loaded with spat. For its part, Bouctouche Bay has always had very impressive collection rates. Figure 9 shows a good collection on the top of a Chinese hat.





**Figure 9 Oyster spat on a Chinese hat**

## **PREDATORS**

In the natural environment, the eastern oyster has many predators, which vary according to the distribution area. In New Brunswick, the main predators are the rock crab (*Cancer irroratus* Say), the mud crab (*Neopanope sayi* Smith), the American lobster (*Homarus americanus* Milne-Edwards), and the Northern sea star (*Asterias vulgaris*). There are other lesser known predators such as oyster borers (small gastropods) and various types of marine worms.

A study by Elner and Lavoie (1983) showed that oysters between 10 and 35 mm in length were easy prey for rock crab and American lobster. Oysters on the sea bottom are particularly vulnerable to predators, but oyster bag rearing practices make it possible to limit predation.

## **DISEASES AND PARASITES**

Diseases are caused by pathogens such as viruses, bacteria, parasites, and fungi. Diseases can also be caused by stress associated with certain environmental factors.

Malpeque disease is probably the most well-known disease in the Maritimes owing to the losses it caused in the past century. Our oysters survived, and today, the stock has been sufficiently re-established to support a commercial fishery in a number of the province's bays. The pathogen that causes this disease has not yet been identified.

At present, there are no known diseases that regularly cause significant losses in our region. Even though the diseases affecting oysters are not common in our region, we

must be vigilant because our neighbours to the south, in the United States, are battling several diseases that are decimating their oyster stocks. Dermo disease, caused by a parasite (*Perkinsus marinus*), and the chronic infections caused by MSX (*Haplosporidium nelsoni*) and SSO (*Haplosporidium costali*) are having devastating effects on oyster populations on the American east coast. MSX and SSO were observed for the first time on Canada's east coast in 2002. In France, the parasite *Bonamia* almost wiped out the European oyster (*Ostrea edulis*) population.

Although these parasites have long been the subject of research, much remains to be discovered about their biology. For example, the life cycles have not been defined, and their propagation methods are not known. Oyster aquaculturists are therefore well advised to follow strict introduction and transfer standards in order to avoid contamination by these undesirable parasites.

Boring sponges (*Cliona ssp.*) (Figure 10) have been reported throughout the Maritimes. The large number of tunnels bored by this sponge weaken the shell considerably. The sponge is relatively small and yellow in colour. It is a filtering organism and uses the shell of the oyster as its home. The holes about 1 mm in circumference on the surface of the shell are used as an entrance and to evacuate water.



**Figure 10** Oyster shell bored into by a sponge

The sponge propagates in two ways. First, it lays eggs that become larvae that swim in the marine environment. The larvae are carried by the currents. They attach themselves to a shell and start to bore holes. The second method is emigration. The sponges move from infected shells to other shells with which they are in contact. This method of propagation is much quicker.

Infested oysters can be treated. Soaking them in a strong brine for about five minutes is a good way to kill boring sponges. Oysters that have been exposed to the air for over an hour need to be soaked for only one minute.

A boring sponge infestation can be controlled with preventive measures. Two effective ways of preventing an infestation are cleaning infested shells off the bottom before starting a sizeable rearing operation and treating the oysters with brine on a regular basis.

## FOULING ORGANISMS, COMPETITORS, ETC.

Almost all of the rearing techniques employed today use structures that float on the surface of the water or are suspended in the water column. These structures provide a collection surface for a multitude of marine organisms.

The blue mussel (*Mytilus edulis*) settles on anything that offers an adequate substrate. Cultivated oysters and the structures in which they are held sometimes become covered in mussel spat, which reduces oyster growth considerably. If measures are not taken to eliminate the accumulation of mussel spat, cleaning will be difficult and costly.

Besides mussels, barnacles and oyster spat may also invade the rearing structures and the older oyster stock. They too compete for food. Oyster aquaculturists have to clean these organisms off their oysters in order to prepare them for sale. (See **Harvesting** section.)

Many types of algae in the marine environment attach themselves to the walls of rearing structures as well. They are generally very prolific and quickly block orifices, thereby limiting water circulation. Oyster growth may be compromised.

The algae codium (*Codium fragile*), also called the “oyster thief,” has been present in New Brunswick for a few years now. It attaches itself to oysters on the sea bottom and, when it is voluminous enough, drifts away with the currents, carrying the oyster with it.

Tunicates are marine invertebrates. There are several species of tunicate in the coastal waters of the Maritime provinces. Prince Edward Island and Nova Scotia are battling an infestation of tunicates. A non-indigenous species, *Styela clava* (Figure 11), invades rearing structures off the coast of P.E.I., while an indigenous species, *Ciona intestinalis* (Figure 12), does the same off Nova Scotia. These species not only compete for food, but they make harvesting more difficult.

In the bays of New Brunswick, Chinese hat collectors are sometimes covered with a tunicate that is the shape and size of a grape (Figure 13). It is called the sea squirt (*Molgula manhattensis*). At the moment, this creature is less of a problem than the tunicates in the other Maritime provinces.



Photo: Neil McNair (PEI-DFAE)

**Figure 11** *Styela clava* (P.E.I.)  
Rearing structure made up of four superimposed oyster bags.



Photo: Clair Carver

**Figure 12** *Ciona intestinalis* (N.S.)  
Tunicates contribute an additional weight of 10 to 20 kg per bag.



**Figure 13** *Molgula manhattensis* (Tunicate or sea squirt)

### **NUTRITIONAL VALUE**

Although oysters do not appear so, they are actually very lean. Oysters contain on average only one or two grams of fat per 100 grams of meat, and they are real cocktails of minerals (copper, selenium, iodine, zinc, iron, etc.) and vitamins (B12, A, E, PP, B1, and B2) In fact, two or three oysters can meet the daily zinc requirements of an adult. Oysters are also a source of protein: 12 to 15 are enough to replace meat at a meal.

## **SITE SELECTION**

A good site must offer both protection and food. It is therefore important to measure all the physical parameters affecting site quality on the basis of the rearing method being considered. The main parameters that make it possible to assess the true potential of a site are as follows:

### **SURFACE AREA**

Obviously, the size of a site has to meet production requirements. Oyster aquaculturists must obtain an aquaculture lease for a site from the New Brunswick Department of Agriculture, Fisheries and Aquaculture. They may apply for a location suited to aquaculture that has the required dimensions and has never been designated as an aquaculture site before. They may also apply for vacant lots. In that case, it is sometimes necessary to combine several non-adjacent lots to obtain the surface area necessary for the production being contemplated.

### **CURRENTS**

In most of the estuaries on New Brunswick's east coast, the velocity of the currents is not high. It generally provides good water exchange. Sometimes a strong wind combined with a tidal current can cause fairly violent eddies. The situation must be carefully assessed. If, however, the currents are truly weak, water exchange could be insufficient to meet the requirements of a sizeable rearing operation. Slower growth and silting can result from such a phenomenon.

### **PREVAILING WINDS**

The prevailing winds can interfere considerably with certain types of rearing operations. The winds create a surface wave that has an impact on off-bottom rearing equipment and can harm new oyster growth. If the prevailing winds persist, annual growth is reduced significantly. In the past, strong winds have washed ashore oysters reared on shallow sites. It is therefore necessary to select sites that are sheltered from the prevailing winds. If this is not possible, the use of a breakwater may be recommended. An effective breakwater remains to be developed.

### **ACCESSIBILITY**

The distance between the rearing site and the offloading site can be a major constraint to the management of aquaculture operations. Fuel costs will be proportionate to the distance to be covered.

Certain sites are hard to get to at low tide. Oyster aquaculturists therefore have to adapt to the tidal cycle, which does not always keep traditional hours.

## DEPTH

Depth should be assessed on the basis of rearing requirements. The storage of oyster aquaculture equipment on the sea bottom during the winter is limited by depth. The space required between the bottom and the surface below the layer of ice at low tide must therefore be calculated. This calculation must take into account maximum ice thickness (Figure 14).

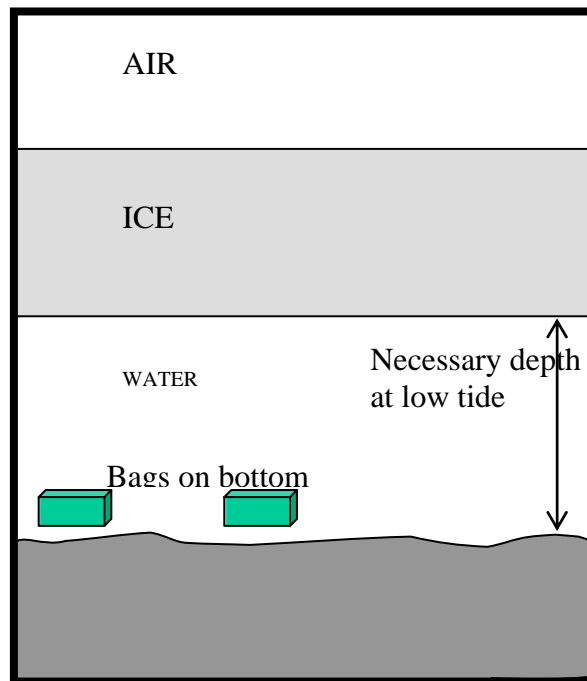

**Figure 14** Arrangement of bags on the bottom during the winter

The arrow indicates the distance to be calculated for safe overwintering.

During the summer, the site's depth is determined on the basis of the work method and the type of rearing. On a shallow site, work can be done on foot, whereas deeper sites require the use of a boat or a work platform.

## RIPARIAN OWNERS AND OTHER USERS

Oyster aquaculture is expanding rapidly and takes place in an environment – the sea – where people engage in a wide range of commercial and recreational activities and there are sensitive ecosystems.

Aquaculturists seeking to obtain a site on which to practise modern oyster aquaculture must take these factors into account. They should look first for sites that interfere with other users as little as possible.



## **GROWING AREA CLASSIFICATION**

Three classifications are used in the Canadian Shellfish Sanitation Program: “Approved,” “Conditionally Approved,” and “Closed.” Each classification is related to the bacteriological quality of the growing waters, the actual and potential sources of pollution, and to some extent, the shellfish resource utilization of the area.

### **Approved Growing Areas**

General definition - shellfish growing areas may be designated as “Approved” if the following conditions are met:

- a) the area is not contaminated with faecal material, poisonous or deleterious substances or marine biotoxins to the extent that consumption of the shellfish might be hazardous;
- b) the median or geometric mean faecal coliform Most Probable Number (MPN) of the water does not exceed 14/100 mL, and not more than 10% of the samples exceed a faecal coliform MPN of 43/100 mL, for a five-tube decimal dilution test.

### **Conditionally Approved Growing Areas**

General definition - shellfish growing areas may be designated as “Conditionally Approved” if the following conditions are met:

- a) during those times when harvesting is permitted, the area meets all of the requirements of an “Approved” area;
- b) conditions which preclude harvesting in areas designated “Conditionally Approved” must be:
  - 1) easily identified by routine measurement and reporting; and
  - 2) predictable and/or controllable.

### **Closed Growing Areas**

General definition - shellfish growing areas are designated as “Closed” under any of the following conditions:

- a) the area is contaminated with faecal material, poisonous and deleterious substances to the extent that consumption of the shellfish might be hazardous;
- b) the median faecal coliform Most Probable Number (MPN) of the water exceeds 14/100 mL, and/or more than 10% of the samples exceed a faecal coliform MPN of 43/100 mL, for a five-tube decimal dilution test;
- c) the paralytic shellfish poison (PSP) concentration is 80 micrograms per 100 grams (80 µg/100 g) and/or amnesic shellfish poisoning (ASP) concentration is 20

micrograms per gram (20 µg/g) of edible portion of raw shellfish meat, or other neurotoxic shellfish poison is found in detectable levels (taken from the Canadian Shellfish Sanitation Program – *Manual of Operations* – Growing Area Survey and Classification).

### **Unclassified Growing Areas**

Unclassified growing areas are managed as closed growing areas because no sampling has been done there for classification purposes. The current leasing policy of the New Brunswick Department of Agriculture, Fisheries and Aquaculture does not authorize the obtaining of leases in unclassified growing areas.

## **LEASES AND LICENCES**

You are the lessee of a site if you hold an aquaculture licence in good standing issued by the Province of New Brunswick and you have your lease in your possession. To obtain these documents, you must apply to the New Brunswick Department of Agriculture, Fisheries and Aquaculture. Applying for an aquaculture licence or a site lease requires a monetary investment.

The steps in the process that cost money are as follows:

- Applying for an aquaculture site;
- Applying for an aquaculture licence;
- Taking out newspaper ads.

If the application is approved and a site may be allocated, the costs are as follows:

- Cost of surveying the site;
- Annual cost of lease;
- Annual cost of aquaculture licence.

A number of resource persons with different federal and provincial departments have to evaluate your application for an aquaculture site and licence. The process is therefore relatively long. All applications relating to sites on which rearing structures are to be placed will require an environmental impact assessment in order to meet the standards of the *Canadian Environmental Assessment Act*. Submission of an application does not necessarily mean the application will be approved. The final decision is based on the review of the application.

## **SITE MARKING**

When you lease an aquaculture site, you are responsible for identifying the precise boundaries of the site. Site marking policies have been established by the Canadian Coast Guard (CCG) and take precedence over the marking policies of the New Brunswick Department of Agriculture, Fisheries and Aquaculture. In the event of a CCG exemption, the provincial policies will apply.

These policies pertain to the size, shape, and colour of the buoys that must be used. They describe the anchoring methods and the criteria concerning spacing between the buoys. In addition, they specify what information must be printed on the buoys.

## SPAT SUPPLY

To establish stable production, oyster aquaculturists must obtain spat every year. There are three ways of obtaining spat: collection in the natural environment, purchase of spat from a specialized producer, and purchase of spat from a shellfish hatchery. Remote setting could eventually be added to this list.

Each method has its own individual characteristics. Table 1 provides information about the three sources of spat.

**TABLE I     Origin of spat and information**

COLLECTION IN NATURAL ENVIRONMENT		SHELLFISH HATCHERY
OYSTER AQUACULTURIST PRODUCER	SPECIALIZED PRODUCER	
Inexpensive	Supply according to availability	Uniform spat size
Collection varies from year to year	Prices vary according to size	Available in the spring
Large spat (5 - 15 mm)	Several size groups (5 - 45 mm)	Small spat (2 - 5 mm)
Collection in summer	Possibility of shortening the buyer's rearing cycle	Possibility of genetic selection
Must have collectors and manage setting		Limited availability at present
Collection not guaranteed		

### SHELLFISH HATCHERY

A shellfish hatchery is a business that specializes in the production of juvenile molluscs. Oysters, soft-shell clams, surf clams, and quahaugs are the species most in demand in the Atlantic provinces.

Operating a hatchery involves four stages that are equally important: food production, broodstock conditioning, mollusc larvae rearing, and spat rearing.

The construction and operation of a hatchery require considerable expertise. The paragraphs that follow provide a brief description of the stages involved in operating a hatchery. For more information, specialized reference manuals should be consulted.

## Food Production

The food used in shellfish hatcheries consists of living single-celled algae. With strains purchased from specialized laboratories, the different species of algae develop in transparent tanks containing several litres of seawater that was filtered and purified beforehand. The algae are exposed to light on a continuous basis, and nutrient salts are added regularly to the culture medium. The algae room (Figure 15) is separate from the hatchery's other units because the culture conditions require rigorous controls. Air and water temperature must remain constant while the hatchery is in operation.

Broodstock conditioning and larvae production require a large quantity of food. A hatchery therefore needs several litres of food every day. The principle is simple. The algae are inoculated into small flasks. When the algae density per millilitre of water is sufficient, the content of the flasks is poured into 20-litre bottles. After about seven days, the algae density per millilitre increases from a few hundred cells per millilitre to several million. The bottles are then used to feed the mollusc larvae and to inoculate 170-litre containers. A week later, the contents are used to feed the broodstock or the spat.



**Figure 15** Algae room

The 20-litre bottles can be seen on the shelves, and the 170-litre containers are located at the back of the room.

### **Broodstock Conditioning**

The broodstock are the parents. They were either taken from the natural environment or have been part of the hatchery's stock for several years. The broodstock are placed in tanks where water circulates continuously or in a closed loop and is kept at a desired temperature for conditioning. The water is filtered, and food is added to it. Under these conditions, it is possible to have broodstock that are ready for reproduction within four to eight weeks.

Once the broodstock are properly conditioned, they are placed in small tanks of clean water, and a stimulus is used to induce spawning. In the eastern oyster, an increase in water temperature of a few degrees is sometimes enough to induce spawning. The females' eggs and the males' sperm are collected and mixed together to produce fertilization. Twenty or so males and females can easily produce some 10 million larvae in a single spawning.

### **Larval Rearing**

Once the eggs have been fertilized, they are placed in rearing tanks. The eggs need about 24 hours to be transformed into free-swimming larvae.

The rearing environment is a closed-loop system. The larvae are placed in tanks containing several hundred litres (Figure 16) of filtered, purified water kept at a constant temperature. They are fed microscopic algae regularly. Every two or three days, the rearing tanks are emptied, washed, and disinfected. The larvae are collected on different filters and sorted. They are then put back into the clean tanks.



**Figure 16 Larval rearing tank (1,100 litres) in a multifunctional room**

The larvae remain in the tanks until they undergo metamorphosis and become sedentary. At that point, they are placed in growout structures designed for spat. A larval cycle can last between 10 and 20 days depending on the species. For instance, it takes the eastern oyster from 15 to 20 days to go from fertilized egg to spat.

## Spat Rearing

Spat are a bit more robust than larvae. They are more tolerant of changes in the rearing conditions. Several types of tanks have been designed for spat rearing. Upwellers and downwellers are two types of tanks commonly used in hatcheries (Figure 17).



**Figure 17** Downweller system used in hatcheries

Each grey tube can hold several thousand spat.

During this last stage in the hatchery rearing cycle, the spat grow from a few hundred microns in size to about 5 mm. During that time, the tanks must be cleaned every day and the spat fed continuously. Individuals are sorted out to eliminate the slow-growing ones. Once the spat reach a certain size, they need a large amount of food and must be transferred to rearing structures outside the hatchery.

A commercial hatchery can supply millions of oyster spat to oyster aquaculturists. The spat are purchased in the spring when they are about 5 mm in size.



## COLLECTION IN THE NATURAL ENVIRONMENT

Oyster aquaculturists and seed oyster producers set a large quantity of collectors in the water every year to collect spat. The collectors used are Chinese hats and plastic tubes (Figure 18). Other collectors such as the Pleno, grooved tubes, smooth tubes, and shells have been tested but with mixed results.

The spat are generally removed from the collectors in September (or the following year). After the spat are removed, they are placed in 2- or 4-mm bags. These are overwintered until May either in cages that can hold a total of five bags or individually. In May, the volume per bag is reduced to meet production assumptions.



**Figure 18** Oyster collectors

On the left is a stack of Chinese hats, and on the right, a six-pack collector consisting of six 45-cm sections of drain pipe.

## Collection on Collectors

Introduced in New Brunswick in the 1970s, the Chinese hat has proved to be an effective collector. For the past few years, a home-made collector developed by oyster aquaculturists has been used. It consists of six sections of drain pipe (six-pack). The popularity of this collector stems from the fact that it is much less expensive and easier to remove the spat from. The collection rates for the two types of collectors are comparable because the collection surface area is about the same. Both types of collectors need to be limed.

The text below is based on the *Oysterculturist Manual*. The description of how to lime Chinese hat collectors is included in this guide as a reminder.

## Liming of Chinese Hat Collectors

Liming is usually done in June. It involves rolling the stacks of Chinese hats in a mixture in a liming tub (Figure 19).

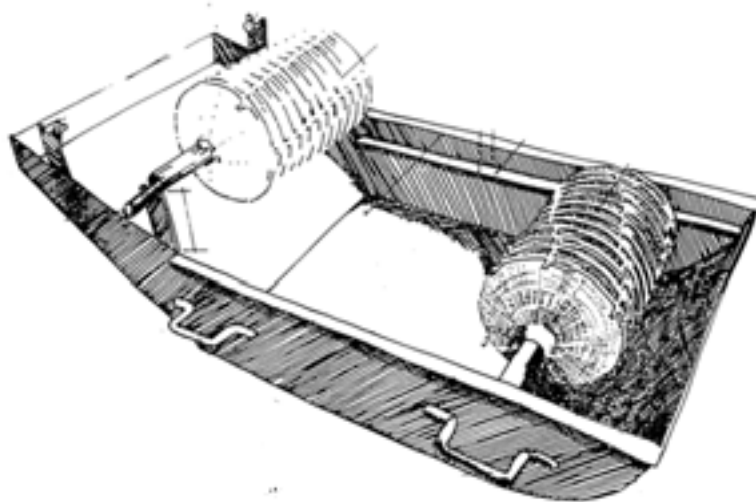

**Figure 19** Liming tub

The mixture is made of equal volumes of cement, slaked lime, and moderately fine sand. Enough water is added to give it the consistency of purée required to produce a uniform layer of about 2 mm.

After being rolled in the mixture, the stack of collectors is put on a rack to drain and then placed upright on a box covered in wire mesh to collect the surplus mixture. This surplus can be reused.

A 23-kg bag of lime, a 40-kg bag of cement, and an equivalent amount of sand is enough to lime between 15 and 18 stacks of Chinese hats. An additional 10 to 15% will be required for stacks that have never been limed before.

The mixture is checked throughout the liming process to ensure uniform consistency.

To obtain excellent results, five or six persons must work together. They will have to protect their hands from the lime and cement. Such a team can lime 600 stacks of collectors in an eight-hour work day.

The stacks of Chinese hats will have to be kept out of the wind and sun and sprayed with water for three or four days after they are limed. This is necessary to prevent the mixture from hardening too fast, forming cracks, and being worn away by waves and currents. That would result in losses for the oyster aquaculturist.

After three or four days, the stacks of Chinese hats are taken outside to allow the mixture to harden and to be washed by the rain. The stacks should be left outside for two weeks before they are used to collect spat.

### **Collection Yield**

One stack of Chinese hats can collect between 5,000 and 100,000 spat, but when the spat are removed, a yield of 5,000 is considered acceptable. At that density, the spat can reach a size of more than 10 mm by the fall. Conversely, a collection of 100,000 spat per hat is problematic. There is competition for space and food. The final size in the fall will be only a few millimetres.

It is fairly easy to estimate the number of spat collected on Chinese hats. The area of the top of a hat is 900 cm<sup>2</sup>. The oyster aquaculturist has only to count the number of spat on a 100-cm<sup>2</sup> surface (10 cm x 10 cm) on 10 or so randomly selected hats and do the appropriate multiplications. The underside and top of the hat must be assessed separately since collection often varies considerably between the two surfaces.

## **Spat Removal**

Spat removal consists in stripping the cement and the oysters off the collector. This can be done manually or mechanically. The manual method is used when the oyster aquaculturist does not have many collectors. For large quantities of collectors, a stripping machine is generally used.

### ***a) Manual Method***

An oyster aquaculturist can dismantle the Chinese hats one by one manually and remove the spat from 25 stacks of Chinese hats in a day. This method involves separating and flexing the hats to remove the oysters. It is easy to remove the spat from six-packs as well. They must be compressed enough to break the cement.

### ***b) Mechanical Method***

Mechanical spat removal is done using a stripping machine (Figure 20) designed for Chinese hats. Oyster aquaculturists using more than 100 collectors need a stripping machine. With this machine, they can remove the spat from 25 stacks per hour with the help of two workers. It can be shared by several oyster aquaculturists to reduce costs.

Stripping machines compress the collectors, thereby breaking the cement on the surface of the hats. Spat removal can be done in the oyster aquaculturist's shed or on the rearing site. Stripping machines are not 100% effective. There are always a few oysters and some cement left on the hat after removal. That is why a final manual stage is required.

Spat can also be mechanically removed from six-packs using a stripping machine designed specifically for that type of collector.

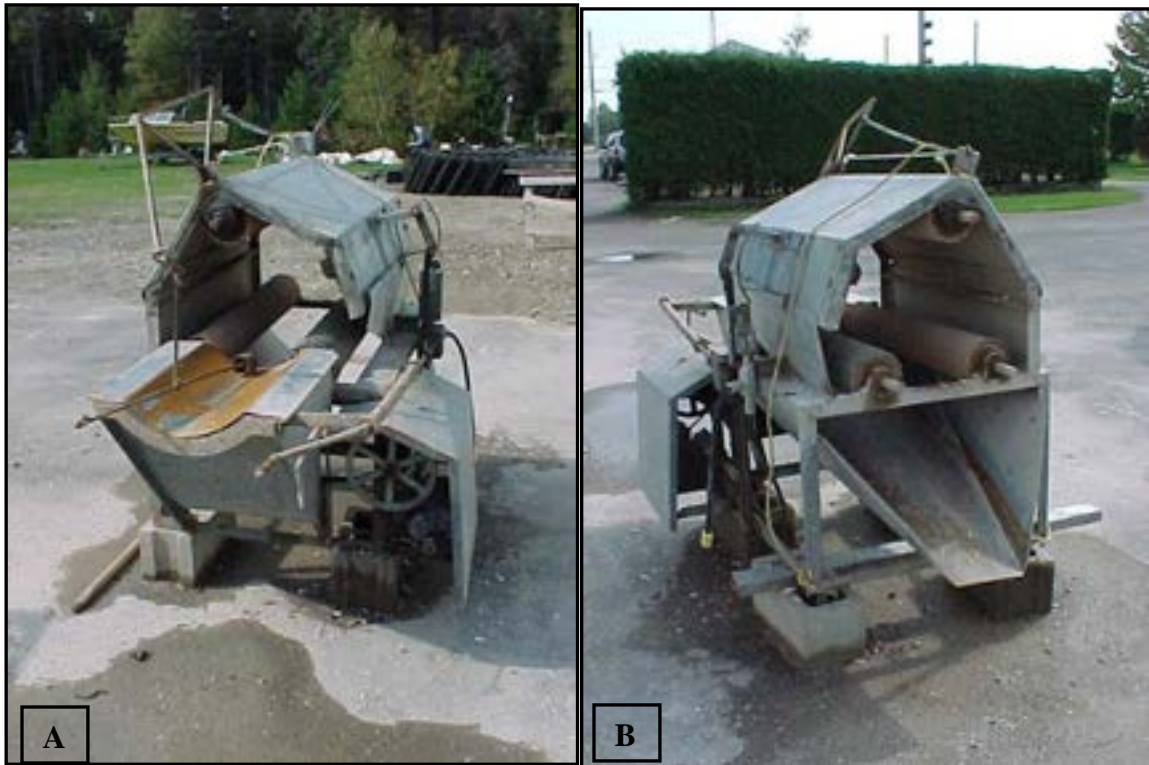

**Figure 20 Stripping machine (A – entrance B – exit)**

This machine runs on an electric motor and can operate with a water jet as well.

### **REMOTE SETTING**

This technique is used extensively on the American west coast. Remote setting consists in submerging the collectors in tanks filled with seawater containing oyster larvae that are ready to settle. Oyster aquaculturists can therefore use this method in the spring to obtain a supply of spat instead of waiting for natural collection, which takes place in the summer.

The larvae come from shellfish hatcheries. This technique is used mainly to make up for a lack of collecting in the natural environment or irregular collecting. Trials involving Chinese hats have been done in New Brunswick, and the results show that there are certain advantages to remote setting. Spat that are remotely set in early May achieve a final size in the fall that is greater than that of naturally collected spat. However, the additional costs associated with food, heating the water, and equipment make this practice non-cost effective. In any case, spat collection in the natural environment is very regular in New Brunswick, and there is no evidence of any need to develop this technique.

## **TRIPLOID OYSTERS**

Triploid oysters have an additional set of chromosomes. This abnormality causes sterility, meaning that the oysters cannot reproduce. There are two ways of producing sterile oysters: the reproduction of individuals from tetraploid oysters (four sets of chromosomes) and induction by chemical treatment. Figure 21 illustrates the natural reproduction process and manipulated reproduction.

There are certain advantages to rearing sterile individuals. All of the oysters' energy goes towards growth and not towards reproduction. Growth can be faster, but the main advantage is that sterile oysters will stay plump during the summer. Normally, the meat index of oysters that reproduce is considerably lower after spawning.

In Europe, especially France, and on the west coast of the United States, the use of triploids oysters is growing. The technique has been refined, and hatcheries have mastered the triploid production process with Pacific oysters. However, the results are different on the east coast of North America. Trials have been carried out, but triploidy has not yet had a significant impact on oyster aquaculture.

Triploid oysters are produced in hatcheries through the application of a special treatment to fertilized eggs. After normal fertilization, the progeny contain the same number of chromosome pairs (two copies of each chromosome) as the parents, with half of the information coming from the male and the other half from the female. Following triploidy induction, the progeny contain three copies of each chromosome.

Spermatogenesis is the process by which sperm are produced. The spermatocyte is the specialized cell that produces sperm. A spermatocyte contains all of an animal's genetic information and generally produces four sperm, each containing half of the male's genetic information.

Oogenesis is the process by which the oocytes produce female gametes (the eggs). In oysters, the egg contains double the amount of the mother's genetic material. It releases the surplus after fertilization by the sperm.

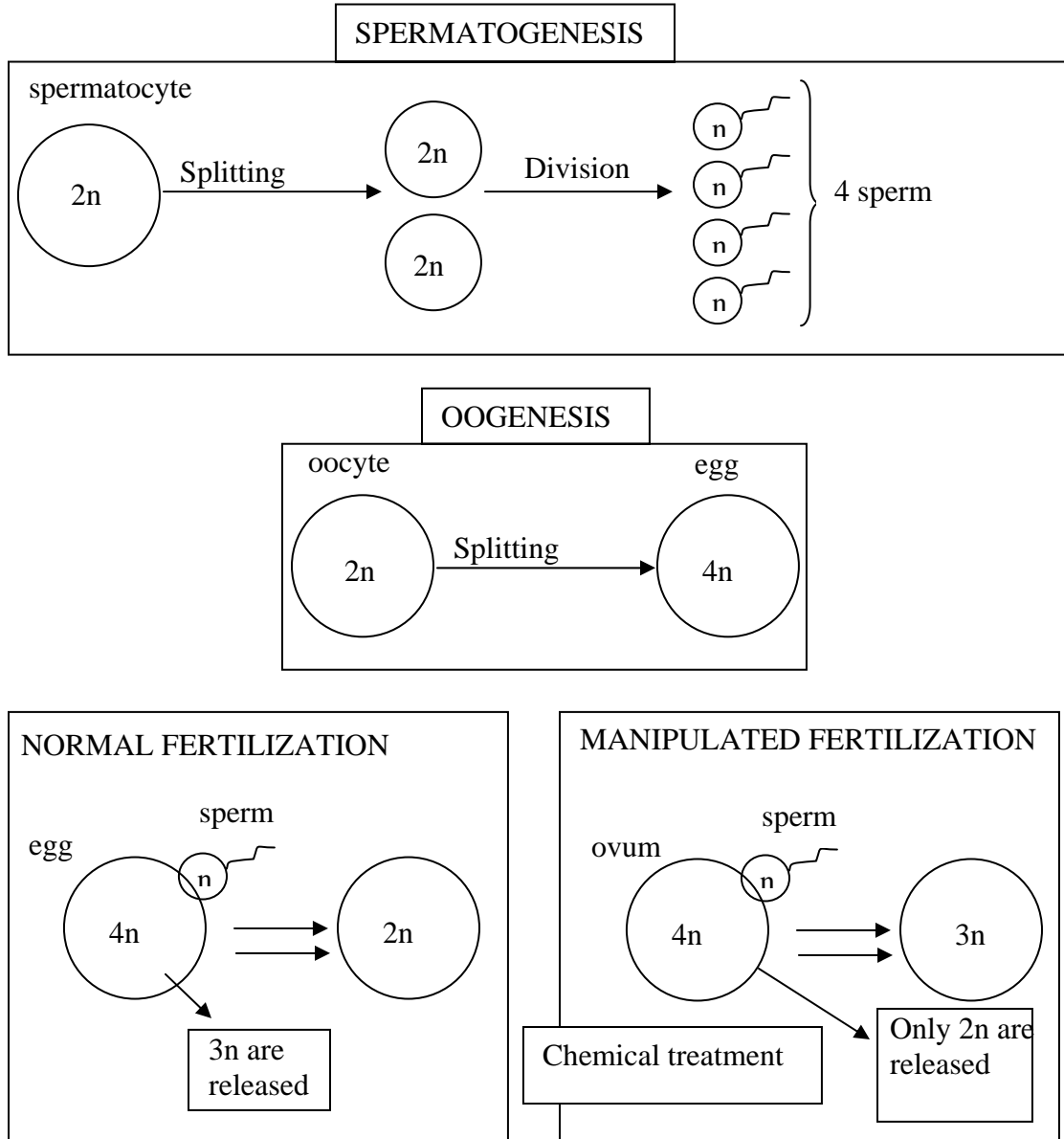

**Figure 21 Description of triploidy**

NORMAL FERTILIZATION produces a diploid individual ( $2n$ ) containing the same number of chromosomes as the parents, whereas MANIPULATED FERTILIZATION produces a sterile triploid individual ( $3n$ ).

## NURSERY

Any rearing device in which seawater circulates can be considered a nursery system. A nursery is defined more specifically as a rearing facility for juvenile animals. Oyster bags are used as a nursery system when the size of the oysters ranges between 5 and 15 mm. However, there are devices used only for rearing juveniles that would not be cost effective to operate for the production of commercial-sized individuals.

### FLUPSY

A Flupsy is a nursery system that promotes the growth of oyster spat and spat of other species of commercial value (Figures 22, 23 and 24). The word Flupsy comes from a combination of three words: Floating Upweller System.

Upwelling is the principle by which the water at the bottom rises to the surface. A Flupsy is actually a device that creates an upwelling current through cubical bins, allowing water to flow up through the screened bottoms. The bins are located on either side of a central channel that is an integral part of a floating platform. A propeller at the channel's exit creates the current. A sealed electric motor turns the propeller.

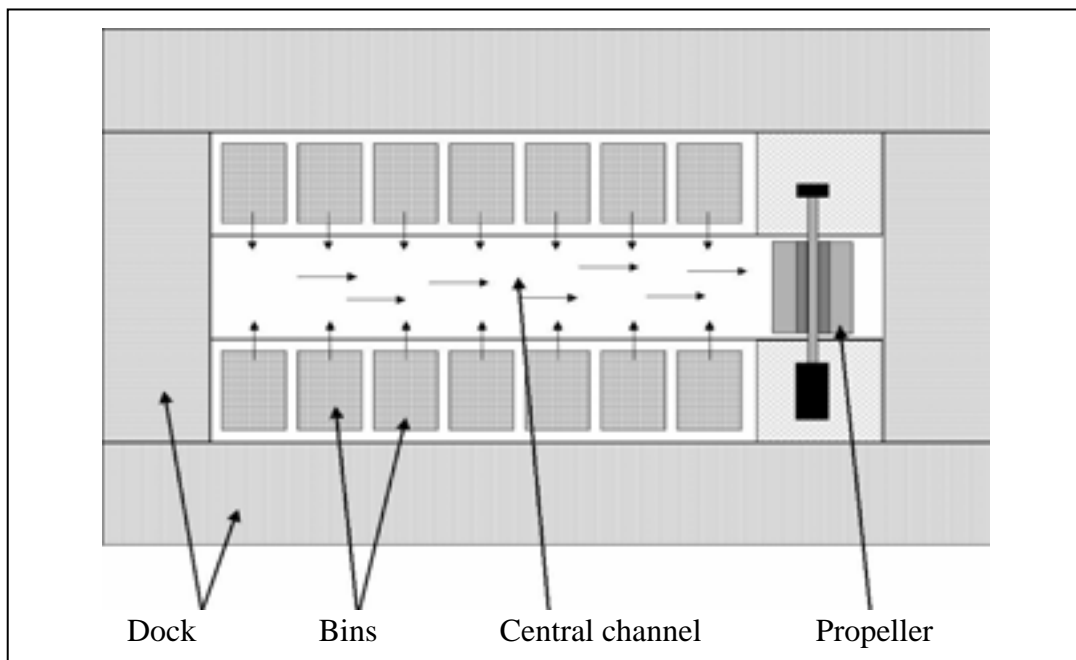

**Figure 22** Diagram of a Flupsy - overhead view

The arrows in the central channel show the direction of the current created by the propeller.

The mollusc spat are placed on the screen on the bottom of the bins. The fast-circulating water (several thousand litres per minute) carries large quantities of food to the thousands



of spat in the bins. Although the density is high, growth is still considerable owing to the ratio of flow to biomass. A 5-mm oyster can grow to 15 mm in four weeks.

There can be several million spat in a Flupsy at the same time. Cleaning is essential. The bins must be removed by means of a winch, and the bins and the molluscs they contain must be washed. This has to be done at least once a week.

A Flupsy is used for specific purposes. It would not be cost effective to build a Flupsy to bring spat to market size. A Flupsy is quite expensive to build. In addition, the locations where such a device can be installed are limited.

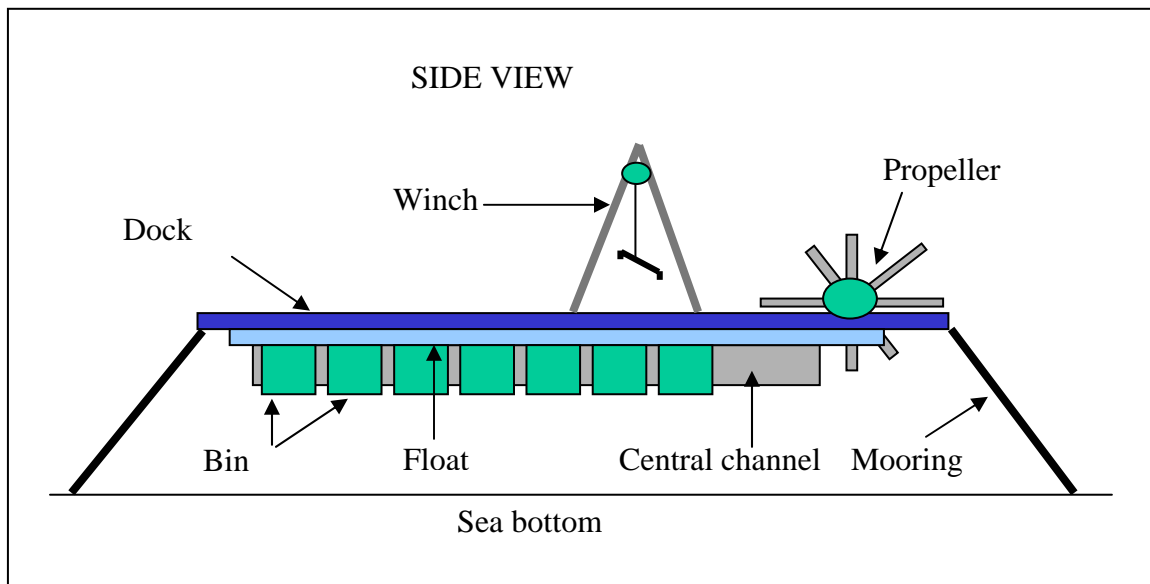

**Figure 23** Illustration of a Flupsy

No dimensions are given because the size of a Flupsy varies depending on the production requirements.



**Figure 24**    **Samples of two types of construction**

The upper photo shows a Flupsy made of wood and metal, while the bottom one shows a Flupsy made of metal.

## REARING METHODS

This guide looks only at off-bottom rearing methods since bottom culture was described exhaustively in the *Oysterculturist Manual* (Ferguson, 1984).

In the late 1990s, oyster bag rearing trials attracted the interest of oyster aquaculturists. Oyster growth was unprecedented, making it possible to anticipate marketing the product in a short period of time. There are definite advantages to using this method: control of the stock, reduced losses owing to predation, easier harvesting, excellent meat quality, and attainment of commercial size in less than four years.

### FLOATING BAGS

The floating bag technique uses a series of oyster bags maintained on the surface of the water in which the oysters are reared. Two cylindrical buoys attached to either side of the bags (Figure 25) keep them afloat. There are almost as many ways of arranging the bags on the surface of the water as there are oyster aquaculturists. The technique described in this manual is based largely on the one currently used in New Brunswick.

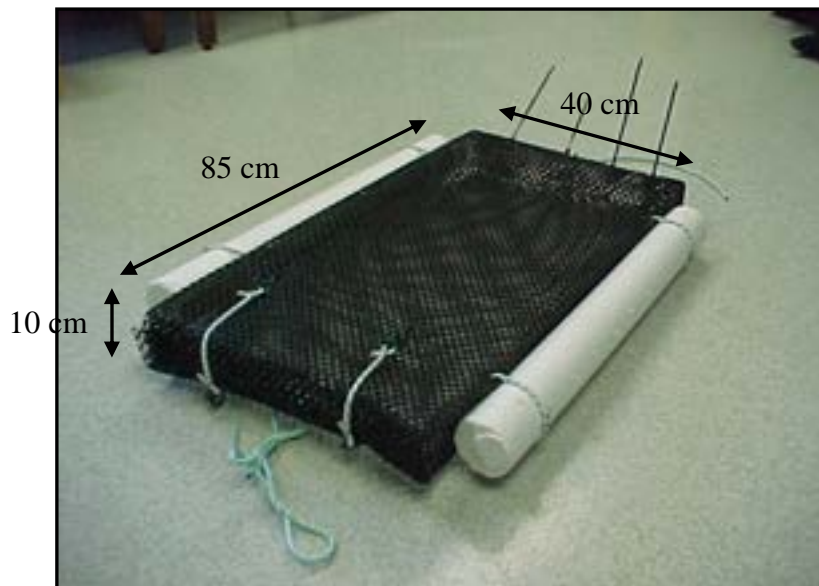

**Figure 25** Oyster bag

Oyster bag made of fairly rigid plastic netting (Vexar) attached to two polystyrene cylindrical buoys with elastic bands.

## **Layout of Longlines**

A typical longline consists of two rows of about 50 bags (Figure 26). The bags are kept together by a system of ropes and rigid crossbars. The longline is anchored to the bottom by metal screw anchors driven into the sediment. These screw anchors are securely attached to the longline and eliminate any risk of drag, something that conventional anchors cannot do. A longline is about 60 metres long and 2.4 metres wide, and the crossbars are placed at both ends and regularly spaced to keep the tension between the lines.

The cylindrical buoys attached to the bags keep the longlines afloat. The distance between the longlines must be sufficient to allow for navigation and to provide access to the bags: it is generally between 5 and 7 metres.

Leaving a space of a few centimetres between the bags makes handling them possible (rotation of the bags) and prevents the floats from being damaged. Both ends of the bags are secured to the tension lines by central fasteners.

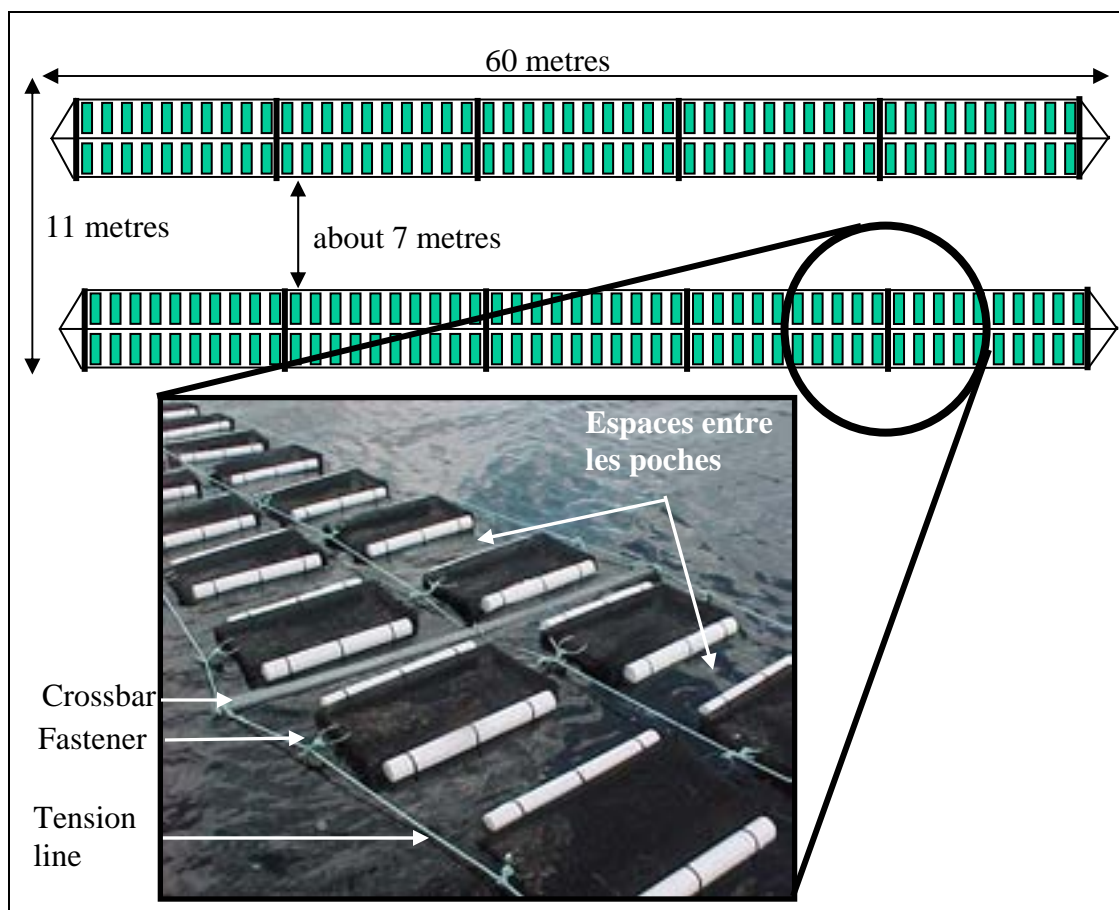

**Figure 26 Oyster bag longline**

The figure shows the layout of two 100-bag longlines on the water surface. In the photo, the tension maintained between the lines and the bags is quite visible.

### Anchoring

To maintain the oyster bag longlines on the surface, oyster aquaculturists quickly realized that conventional anchors were inadequate. They therefore borrowed a technique used by mussel aquaculturists to anchor their longlines (Figure 27). This consists of a screw anchor attached to a metal rod. This type of anchor can be driven into the sediment by hand, although a hydraulic device does the job more easily. It is better to set the anchors in the winter because the ice offers stable support. It is also easier to measure the exact distance between the anchors.

Anchor size varies according to the type of bottom: the softer the bottom, the larger the diameter of the screw anchor. The screw anchors used range between 10 and 15 cm in diameter. The length of the rod varies as well, but there are no specific standards (about 50 cm). The screw anchors are driven into the sediment until the rod is completely buried.

The anchor cables are attached to the screw anchors before they are driven in, otherwise it would be impossible to find them again.



**Figure 27 Helical screw anchor and hydraulic device**

On the left, a screw anchor, and on the right, a hydraulic device used to drive the screw anchors into the sediment.

### **Density**

Density is defined by the number of individuals per surface unit. Bag density is expressed in terms of the number of oysters in the bag (200, 500, 1000, etc.) or in terms of volume (litre) or weight (kilogram). Density has an effect on oyster growth and is closely related to the number of bags required for rearing. Table II shows the commonly used densities and the number of bags required to produce 500,000 oysters.

**TABLE II Rearing density and bags required**

Year	Purchase	Number of oysters	Density (oysters/bag)	Number of bags	Number of bags to be purchased
Year 1	Current year	500,000	1,000	500	<b>500</b>
		Bags required →		500	
Year 2	Current year	500,000	1,000	500	<b>1,000</b>
	Preceding year	500,000	500	1,000	
		Bags required →		1,500	
Year 3	Current year	500,000	1,00	500	<b>2,500</b>
	Preceding year	500,000	500	1,00	
	Preceding year	500,000	200	2,500	
		Bags required →		<b>4,000</b>	
	Sale in fall	500,000	200	2,500	Bags released

Why is it necessary to vary the number of oysters per bag? The rim that forms around the valves as the oyster grows is very fragile and breaks easily. Growth is reduced if the oyster is shaken too vigorously and for too long. Small oysters are shifted easily within the bag, which moves under the action of the waves. Having a sizeable mass of oysters in a bag stabilizes it and limits movement. The weights and volumes corresponding to the suggested densities are shown in Table III.

Having a large number of small oysters in a bag provides stability owing to the additional weight. Waves have less of a hold on the bags because they are less buoyant. Older oysters are larger and heavier. They take up more room in the bags. In order not to overload the bags, density is reduced.

As the preceding paragraph shows, density plays a positive role in stock management, but it can be a limiting factor as well. Growth may be reduced if there are too many oysters in a bag.

**TABLE III Suggested rearing densities**

AGE CLASS	OYSTER SIZE (mm)	DENSITY (oysters/bag)	WEIGHT (kg)	VOLUME (L)
1	15 – 25	1000 – 1500	2 - 3	4.0
2	25 – 50	500	4 – 5	4.0
3	50 - 75	200 - 250	4 - 6	6.0

Here is a quick and easy method of determining the number of oysters placed in a bag. A 1-litre container can be used in nearly all situations.

- 1) Fill the container completely, and count the oysters.
- 2) Do this 10 times.
- 3) Note the number of oysters each time.
- 4) Add up the results of the 10 samples, and divide by 10. This gives the average number of oysters in the container.

Example: The oysters in 10 1-litre containers are counted:

1.	245 oysters	6.	236 oysters
2.	255 oysters	7.	242 oysters
3.	229 oysters	8.	258 oysters
4.	261 oysters	9.	253 oysters
5.	267 oysters	10.	274 oysters

This adds up to 2,520 oysters. Divide by 10 (the number of samples), which gives an average of 252 oysters per litre. If the target density is 1,000 oysters per bag, then four litres of oysters ( $4 \times 252 = 1,008$ ) must be placed in the bag. This can be done manually or mechanically using a bag filler/weigher. (See photos in appendix.)

### Sorting

Oysters grow at different rates even though they may belong to the same age class. The oysters in a bag may not all reach market size at the same time. Oyster aquaculturists must therefore sort their stock.

Sorting is done in the spring and summer. Sorting in the fall is not recommended as it may cause the oysters stress, which they will have difficulty coping with as winter approaches. Oysters will probably not be able to repair a broken shell at that time of year since their metabolism slows down considerably as the water temperature drops.

For small quantities of oysters, sorting can be done by hand using a table to which a metal screen has been attached. The mesh size matches the size of the oysters to be placed in bags. This is a home-made method, and a skilled oyster aquaculturist can easily



build this type of sieve using wood and screening. For larger operations, sorting machines have been developed to carry out this task, which would otherwise take up a great deal of time and require numerous employees. There are two types of machines operating on two different principles.

The first type (Figure 28) is simple and less costly. It consists of a cylinder made of mesh that turns on an axis with different-sized openings. After being fed into the top, the oysters pass through the mesh owing to the rotating action and fall into containers placed under the sorting machine.



**Figure 28** Oyster sorting machine (home-made)

This sorting machine has several sections that make it possible to sort oysters of different sizes. The oysters fall into the tubs that can be seen at the base.

A different type of sorting machine (Figure 29) was designed in Europe where oyster aquaculture is highly developed. Made of stainless steel, it consists of a series of superimposed screens that have different-sized openings and are agitated by means of vibrating movements.



**Figure 29** Vibrating screen (commercially manufactured)

In the top photo, the arrow points to where the oysters come out. In the bottom photo, note the wheels for moving the sorting machine. With this vibrating screen, four sizes of oysters can be sorted simultaneously.

## Overwintering

Oysters lower their metabolism when the water temperature drops below 10°C. They stop filtering completely below 4°C. They do not feed at all during the winter.

In October, as the cold season approaches, oyster aquaculturists start preparing the bags for winter storage. They are placed on the bottom of their lease or suspended out of the reach of ice. Two overwintering methods have been developed. Oyster aquaculturists who use the first method submerge the oysters in growout bags and have only to remove the floats for them to sink to the bottom.

Oyster aquaculturists who use the second method have another series of bags for overwintering. Oysters that spent the summer in growout bags are transferred to overwintering bags. Since they are no longer feeding, between 20 and 22 litres of oysters can easily be placed in one bag. The bags are attached to a line placed on the bottom or suspended in the water column. However, it must be ensured that, as soon as the water warms up above 4°C in the spring, the oysters are re-suspended and the densities are reduced to maximize growth and prevent suffocation. Figure 30 illustrates the layout of a submerged longline. Details concerning overwintering longlines are provided in Appendix III.

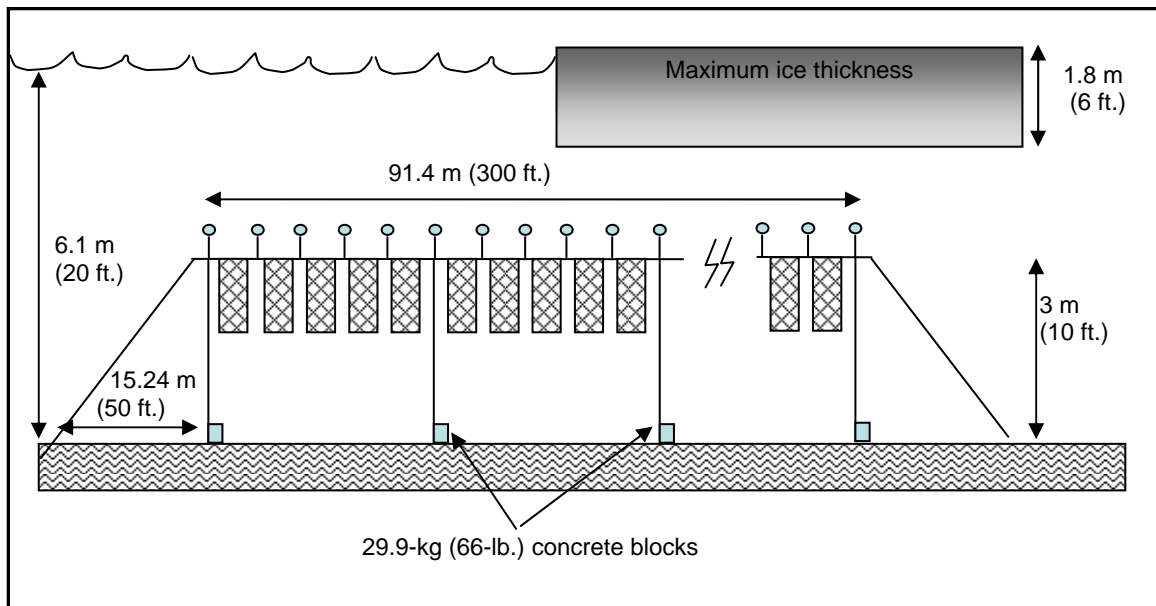

**Figure 30** Diagram of a submerged longline

## Yield

An oyster's growth is inversely proportional to its size. When an oyster is small, it grows much more quickly than when it is large. Under good rearing conditions, it is estimated that a 15-to-20-mm oyster in a floating bag can grow to more than 65 mm in three growing seasons (May to October). Table IV shows the growth rates that are possible under optimum growing conditions.

**TABLE IV Oyster growth under optimum conditions**

YEAR	INITIAL SIZE (mm)	TOTAL GROWTH (mm)	FINAL SIZE (mm)
YEAR 1 (May to October)	15 - 20	15 - 25	30 - 45
YEAR 2 (May to October)	30 - 45	10 - 20	40 - 65
YEAR 3 (May to October)	40 - 65	5 - 15	45 - 70
YEAR 4 (May to October)	45 - 70	5 - 10	50 - 80

Growth is affected by various factors, and the optimum rates are not always achieved. The wide discrepancies in Table IV reflect that fact.

Mortality rates have been scientifically monitored since rearing oysters in bags first began. Under optimum conditions, mortality rates are estimated to be less than 5% per year, but rates can vary considerably depending on local factors.

## Constraints

There are certain advantages to rearing oysters in oyster bags, but there are real constraints as well. Any equipment placed in the aquatic environment quickly becomes a collector for a multitude of marine organisms. Oyster bags are no exception to the rule. The spat of mussels, barnacles, and oysters sometimes settle in large numbers on the bags as well as on the cultivated oysters themselves.

Cleaning off the mussel and oyster spat that settle on a producer's stock can and will result in additional costs during harvesting and during the production cycle. Some oyster aquaculturists have moved their oyster aquaculture tables to the intertidal zone to prevent undesirable organisms from collecting on their stock, but that option is available to only a small percentage of aquaculturists. A brushing machine designed in Europe makes it possible to clean a large quantity of oysters in a short period of time (see **Harvesting** section).

## **Innovation**

The rearing technique used today is constantly evolving. Various elements will probably undergo modification in the near future, such as:

- bag closure method
- method of attaching bags to tension lines
- shape and size of overwintering bags
- location of floats
- polystyrene floats versus high-density polyethylene floats
- PVC crossbars versus metal bars (rebars)
- method of reducing fouling organisms.

The floating bag rearing technique shows real potential, but it must be adapted to the needs of each oyster aquaculturist and each site in order to maximize cost effectiveness. However, caution must be exercised during innovation trials. Making changes to structures and procedures does not always provide adequate solutions to all the problems although, generally speaking, all changes cost the producer money. It is better to carry out small-scale trials and observe the results than to invest in large-scale projects that do not meet all the objectives that have been set.

## **BAGS ON TABLES**

This rearing technique has been adapted from the French oyster aquaculture industry. The French have been producing thousands of metric tons of Pacific oysters on their coast for decades using this method. With a few minor modifications, the technique can easily be adapted to our conditions. The oyster bags are spread out on metal tables about 45 cm high, 1 m wide, and 3.3 m long.

### **Arrangement of Tables**

The tables (Figure 31) are normally placed in the intertidal zone of the rearing site. That makes it easier for oyster aquaculturists to get to their structures and carry out maintenance work at low tide. The bags are securely attached to the tables to prevent them from being washed away by currents or waves. To eliminate the problem of corrosion, the tables are galvanized. Although this increases the cost of the tables by 50%, their greatly extended service life justifies the expense.



**Figure 31** Oyster rearing in bags on tables

## **Density**

Density in the Vexar bags varies according to the size of the oysters. Approximately 1,000 oysters 20 mm in size are placed in the bags the first year. Density is reduced to about 500 the second year and to between 200 and 250 the third year. The quantity of oysters in the bags is reduced to maximize growth and enhance quality.

## **Sorting**

Sorting can be done in the spring before the bags are placed in the water and during the summer. The advantages of sorting are the same as those mentioned in the section on the sorting of floating bags.

## **Overwintering**

Overwintering the bags and tables requires a great deal of time and energy. Different options are available, including the following:

Moving the tables and bags to a deeper part of the site so ice does not damage them.

Removing the bags from the tables, and overwintering them on a location on the site where there is no risk of ice damage. They are attached to a line anchored to the bottom or suspended in the water column. The tables are stored on dry land.

## **Yield**

Rearing oysters in bags on tables is not very different from rearing them in floating bags. Yields are similar, in terms of both growth and survival rate. (For more details, refer to the section Floating Bags - Yield.)

## **Constraints**

Ice is a major constraint for this rearing practice. The tables have to be moved to deeper locations on the site or removed from the water. The availability of sites suited to this rearing method is limited. The popularity of this technique is therefore limited as well. In addition, it requires boats equipped with powerful winches capable of moving around a great deal of equipment.

### **FRENCH LONGLINE (Research and Development)**

In Thau Pond in the Mediterranean area, oyster aquaculturists have developed another rearing method. They cement oysters to strings and suspend them in the water from metal supports. Similar trials have been carried out in northeastern New Brunswick, with promising results. Unfortunately, few aquaculture sites on the province's east coast are suited to this rearing technique, mainly because of the shallowness of the oyster aquaculture sites. However, an attempt was made to adapt the technique, and oysters cemented to strings were suspended horizontally at the surface of the water (Figure 32).



**Figure 32**      **Experimental French longline**

Oysters cemented to strings attached to a longline maintained at the surface of the water by buoys.

At the moment, it is difficult to describe the technique because there are still too many technical details to be worked out. Nonetheless, this rearing method shows some potential. On first observation, we noted that oysters take on a more cupped shape and that growth is comparable to that obtained in floating bags. However, marine fouling organisms (Figure 33) are much more of a problem with this method than with the floating bag method.



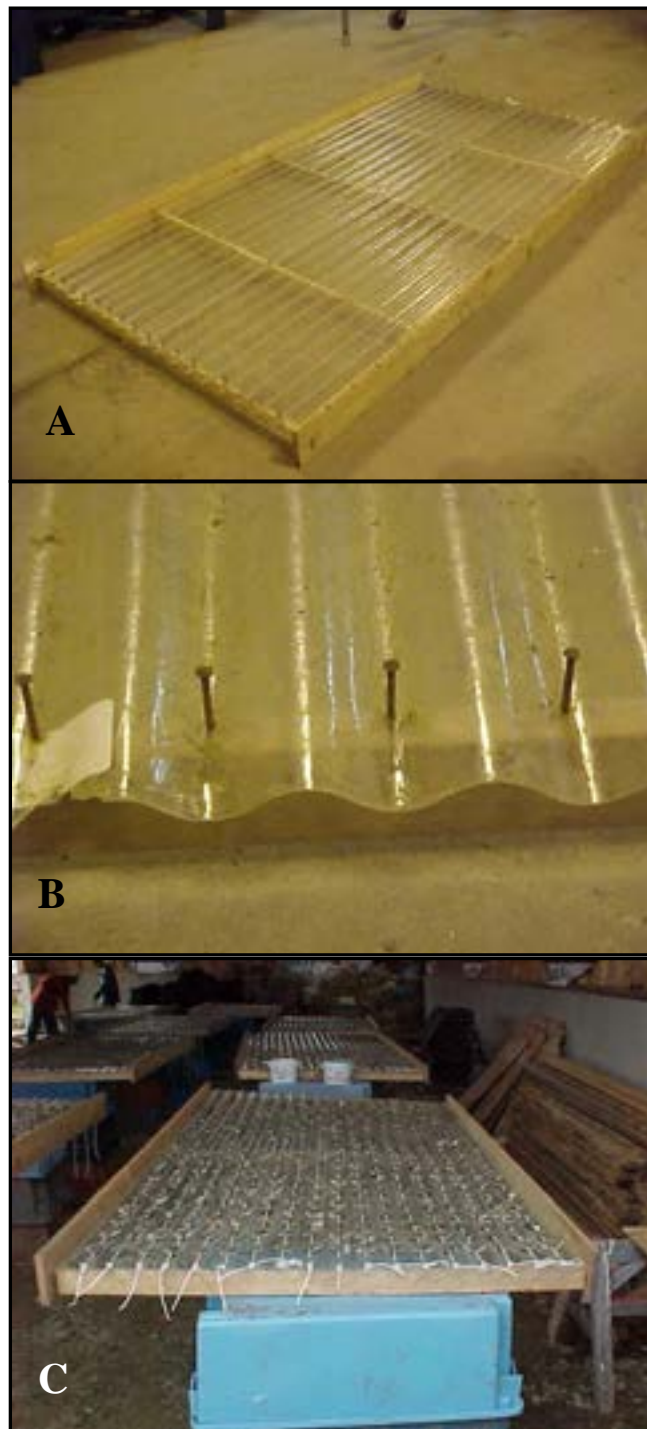

**Figure 33** Marine fouling organisms

Algae can clearly be seen attached to the oysters. Oyster spat (not visible) are another type of fouling organism.

### **Cementing of Oysters**

The process of preparing the strings and cementing the oysters to them is well established in the Mediterranean area. This is the technique that was used here. First, to cement the oysters to the string, a support made especially for that purpose is required. It is made from sheets of wavy fiberglass attached to a wooden structure. In pairs, the oysters are placed between the waves at regular intervals of about 10 cm. The right valve is placed against the sheet of fiberglass, and the hinges of the two oysters must be touching. When the fiberglass panels are full, a piece of string is placed on the oysters and attached at either end of the support to nails that were hammered into the concave part of the wave beforehand (Figure 34). A mixture of cement and water with a consistency similar to that of cold molasses is placed on the string and the oysters. A third oyster is then pressed into the cement above each group of oysters (Figure 35). This must be left to dry for 24 hours. The supports filled with strings of oysters can then be taken to the rearing site.



**Figure 34**      **Cementing support**

- A) Wooden support with sheet of wavy fiberglass.
- B) End of support showing the waves and the nails used to attach the strings.
- C) Support filled with oysters on which strings have been placed.

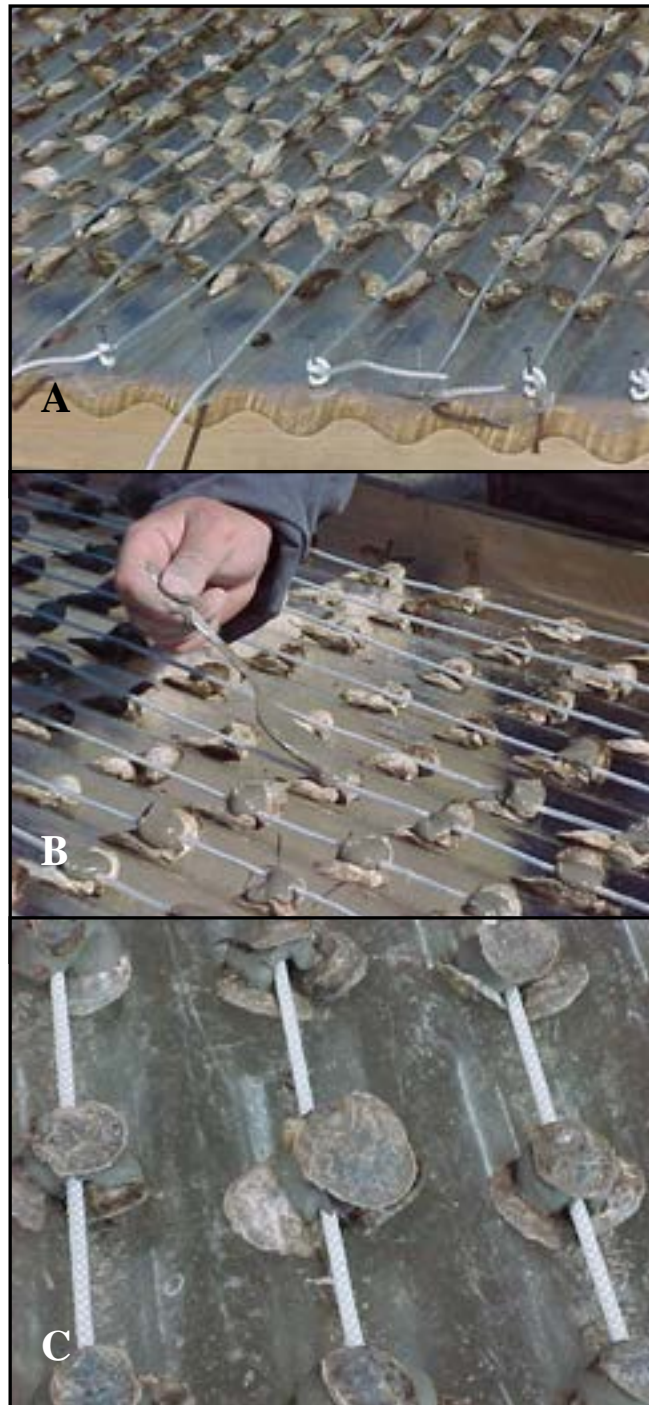

**Figure 35**      **Cementing of oysters**

- A) Oysters ready to be cemented. Note that the right valve is on the bottom.
- B) A small amount of cement is applied to the oysters and the strings.
- C) A third oyster is pressed into the cement. The process is completed, and the support must be left to dry for 24 hours.

### Setting of Longlines

Trials were carried out on a deep (3 metres), sheltered site (Figure 36). Except for a few details, the same technique as the one used in the Mediterranean was tested. The results were very favourable.



**Figure 36** Oysters on strings suspended from rafts

The strings are about two metres long.

On other leases where the water is often less than a metre deep, the technique must be adapted considerably. The structure that was used consisted of three parallel lines kept afloat on the surface of the water by means of conventional buoys (Figure 37).



**Figure 37**      **Experimental longline**

After this manual is published, further testing of rigid structures will likely be carried out. Problems that will need to be addressed include keeping the new structure afloat, controlling fouling organisms, overwintering, and harvesting. The technique's economic feasibility must be taken into account in well.

## HARVESTING

In New Brunswick, until quite recently, oysters were harvested from early fall until early winter. Harvesting was mainly a fishing activity. Quebec and Ontario consumers love seafood from the Atlantic provinces, and during the fall they organize their oyster parties. In France, almost the entire oyster production is sold before Christmas. Our American neighbours eat large quantities of oysters in the fall as well. Product availability has conditioned people to eat oysters in the fall. This seems to be an international tendency.

Oyster harvesting has always been done in the fall not only because the demand is higher then but also because fisheries legislation did not allow harvesting during the other seasons. Today, oyster aquaculture is truly a full-time year-round activity. In order to enable the oyster aquaculture industry to develop, agreements have been signed between oyster aquaculturists and the Department of Fisheries and Oceans. Those agreements allow oyster aquaculturists to harvest their product throughout the year. Also, they do not need to comply with size limits.

The use of oyster bags facilitates harvesting. It is easy for oyster aquaculturists to determine the number of bags they need to remove from the water because they know how many oysters the bags contain. In addition, they can do this year-round because bags on longlines are readily accessible at the water surface or through a hole in the ice (Figure 38).

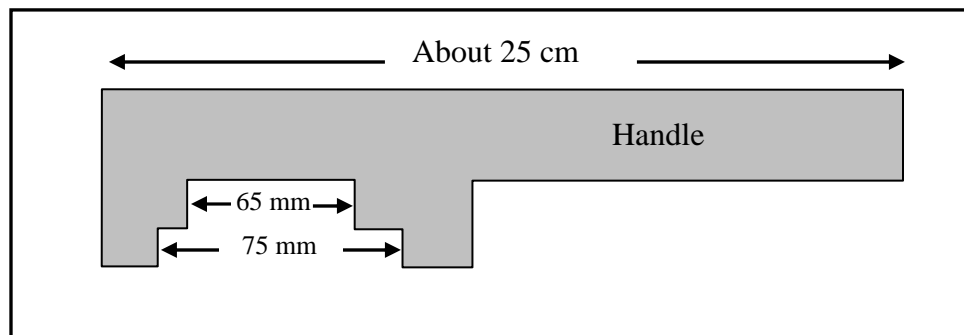

**Figure 38** Harvesting through the ice

Oyster aquaculturists have to prepare their oysters for sale. They must sort and clean them. Sorting is generally done in the summer. The oysters are separated on the basis of

size, i.e., oysters larger than 75 mm are placed together in a series of bags and oysters between 65 and 75 mm are placed in other bags. The latter are cocktail oysters. Although tough, oysters are living animals. They must be handled carefully in order not to harm them. Oysters must not be left in the sun for too long. Also, care must be taken not to break the shell. An oyster that loses its intravalvular liquid will quickly die. Oysters must be stored in a cool place between handlings.

Oysters are cleaned during the sorting process. That is when fouling organisms such as algae, barnacles, mussels, and oyster spat are removed. The quantity of oysters to be cleaned will dictate the method used. Cleaning can be done by hand with an oyster gauge (Figure 39). This tool is used to check the size of the oyster, but it also serves as a lever to dislodge the spat of other mollusc species. For large quantities of oysters, a mechanized oyster washer can be used (Figure 40). This device has proved to be highly effective for cleaning the surface of oyster shells. The cleaning is quite vigorous and can break the shell's rim. It is therefore suggested that cleaning be done after the fouling organisms have finishing settling but early enough in the season for the oyster to regrow its shell. August is a good time for this operation. The washer takes up little room and can easily be used on an oyster aquaculture boat.



**Figure 39** Oyster gauge

Made of metal, it is flat (about 5 mm thick), and the handle can be made of metal pipe about 25 mm in diameter.



**Figure 40** Oyster washer

The motor above the washer turns a series of brushes with stiff bristles that destroy barnacles and oyster spat and remove mussels. The process is done with water.



## PROCESSING

Processing is defined as any operation that involves handling the product to prepare it for sale. Before being shipped, oysters are washed, sorted, and packaged, and the containers are labelled. If the oysters are exported outside the province, the processing plant must be certified by the federal government. For local markets, the processing plant needs only provincial certification. (See *Fish Processing Act*.)

### Washing

The oysters are placed on a table and sprayed with a hose. The water removes the sediment and mud that have accumulated on the shell. A pressurized stream of water is not used because that would break the shells before packaging.

### Sorting

Oysters are sorted on the basis of size to differentiate between cocktail oysters and larger oysters. They are also sorted on the basis of their morphological appearance. A good quality oyster must be fairly thick and have an adequate length-to-width ratio. The shell must be clean and solid. A damaged shell allows the liquid to leak out, and the oyster will not survive storage in good condition. In processing plants, staff are employed to sort the oysters according to four grades (Figure 41) based on a coefficient calculated as follows:

Example of calculation: Oyster 76 mm long and 50 mm wide  
 $76 \text{ mm} \div 50 \text{ mm} = 1.52 \Rightarrow \text{Choice}$

This grade applies mainly to oysters raised using bottom culture methods or fished on public beds. Oysters produced in oyster bags are sold as two grades based on length. Cocktail oysters are between 65 mm and 75 mm, while oysters larger than 76 mm are sold as an aquaculture product at the legal commercial size. It should be noted that oysters produced in oyster bags generally fall into the first two quality grades according to the grading method illustrated in Figure 41.

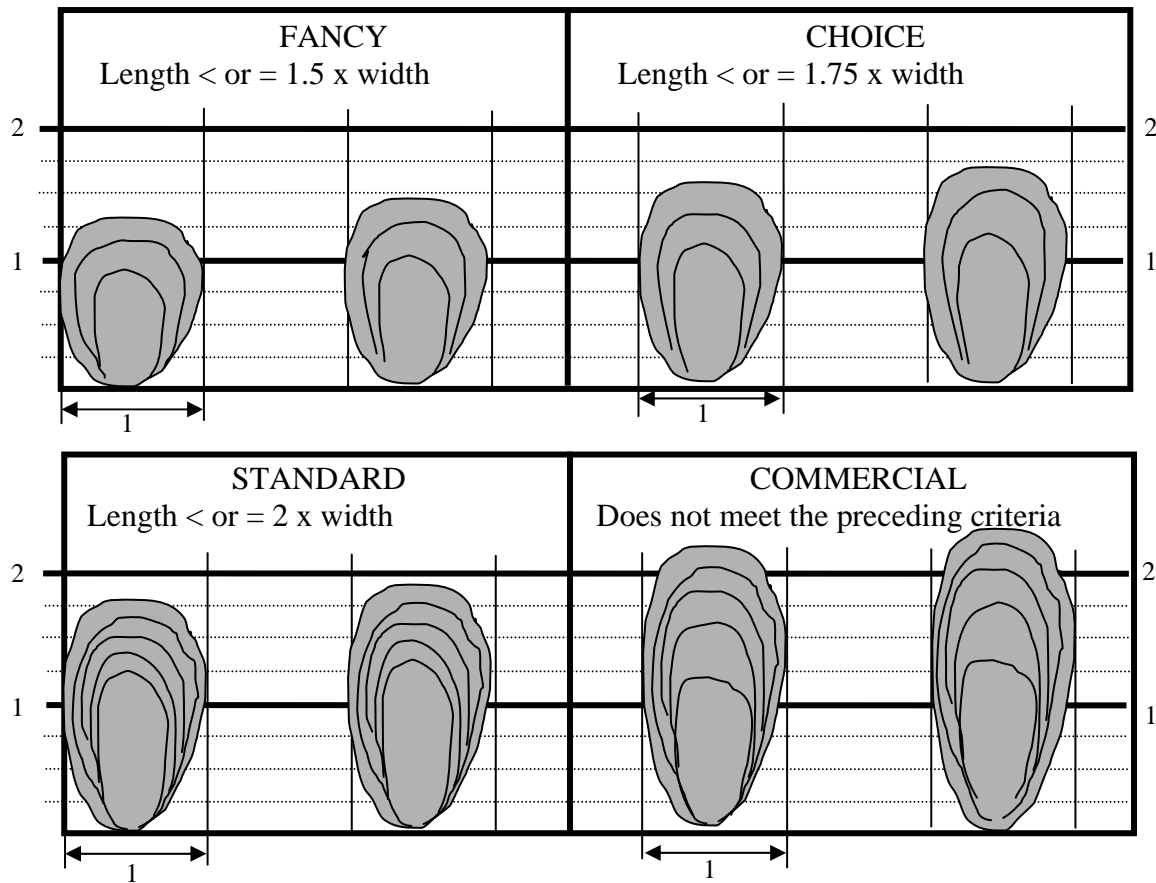

**Figure 41** Grades of oysters

Although many plants have workers to do the sorting (Figure 42), there is a device, called an oyster grader, that can sort mechanically (Figures 43 and 44). A conveyor belt carries the oysters to an image analyzer, which determines the oyster's shape. A computer controls the doors that push the oysters into the appropriate compartments.



**Figure 42** Workers assigned to oyster sorting and packaging



**Figure 43** End of an oyster grader

The doors are located between the two conveyor belts and push the oysters into the appropriate bins.



**Figure 44** Side view of an oyster grader

The collection bins for the different grades of oysters.

### **Packaging and Labelling**

Packaging must be done carefully. Specific numbers of oysters are placed in the boxes. They are laid on their left valves so that the internal liquid remains in the shell. The boxes are then shut and sealed, and labels are placed on the boxes.

The labelling of marine products is regulated with a view to protecting consumer health. However, good labelling has other benefits. A properly labelled product is easy to identify. Consumers can readily locate the products they like, and the information on the labels helps them to ascertain the quality of the product, as well as its origin, date of packaging, and so forth.

The operation of a processing plant is a regulated activity. Anyone considering going into processing should check into and become familiar with the relevant legislation. The investment required to start up and operate a processing plant amounts to several thousand dollars, so it is an expense that should not be taken lightly.

## **DEVELOPMENT OF A SHELLFISH ENTERPRISE**

In New Brunswick, oyster aquaculture was long perceived as a secondary seasonal activity. It generated extra income for a number of inshore fishermen at the end of the fishing season. Today, oyster aquaculture creates full-time jobs and requires major investments. Oyster aquaculturists must be well organized to market the oysters they have been cultivating for three or four years on an ongoing basis.

New entrants to the industry have to develop a strategy that will enable them to identify the opportunities and challenges they face. The business plan is an essential tool for that purpose.

### **BUSINESS PLAN**

“A good business plan is a kind of ‘reality check.’ It helps you to identify the challenges as well as the opportunities your business will face. It forces you to clearly identify your target markets and your competition. It pushes you to think through your operational and financial requirements and how you will handle sales and promotion.” (Taken from *Planning for Success – Your guide to preparing a business plan*). Developing a business plan is demanding work that requires the right knowledge. In some cases, it is advised that a professional be engaged to design the business plan. Even if the plan is prepared by a third party, the oyster aquaculturist’s input is essential. For more information about business plans, the financial agencies that have guides on this subject should be consulted.

A business plan is made up of several important sections, including the following: Cover Page, Table of Contents, Executive Summary, The Business, The Opportunity, Financial Data, and Production Plan. The guides that are available clearly explain the different steps in a business plan. The section of the business plan that requires the oyster aquaculturist’s input is the production plan. The main components of a production plan are described on the following pages.

## PRODUCTION PLAN

A production plan describes the technical aspects of the enterprise. It details a number of essential elements, including the following:

### Rearing Method

The rearing method used forms the basis of the production plan. It helps to determine the space required to achieve the production targets. In addition, it affects the amount of time required to grow the stock to commercial size and makes it possible to determine how many workers will be required during a given production season. The quantity and type of equipment necessary are directly related to the rearing method and the scale of production.

### Use of Space

This depends on the production cycle. To establish a viable operation, it is important to identify the surface area required to meet the production targets. The surface area used for immediate production, for overwintering, and for navigation corridors must all be taken into account (Figure 45). The amount of space necessary to float 20 oyster bag longlines is equal to one hectare. Navigation corridor requirements will be determined on the basis of local occupancy rates. Normally, overwintering spaces are located in the deep part of the lease, whenever possible.

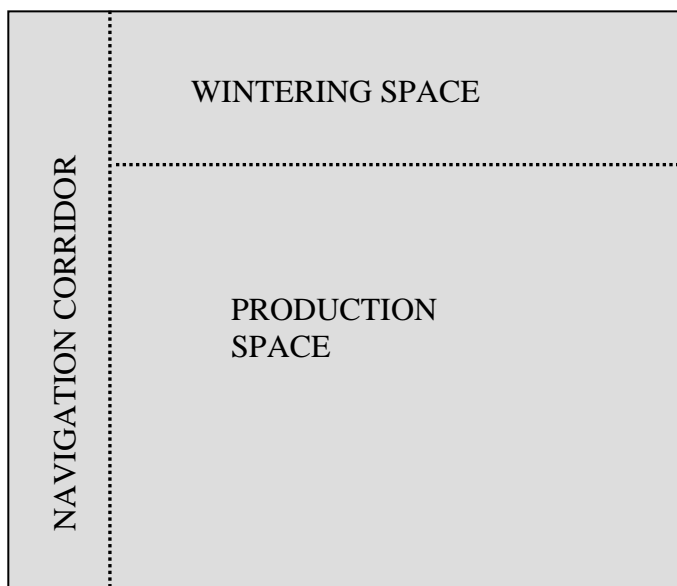

**Figure 45** Diagram illustrating the use of an aquaculture lease

Note that the dots are positioned arbitrarily and that the defined areas are not to scale.

## Production Cycle

The time required to grow oyster spat to commercial size defines the production cycle. The production cycle determines when the product will be marketable. The survival rate must be known as well. These parameters have an impact on the amount of equipment required and the revenue generated. Table V illustrates the fluctuations in a stock consisting of 500,000 seed oysters purchased annually and reflects a survival rate of 95% per year. The initial size of the oysters varies from 15 to 20 mm, and all of the stock is sold after spending three years in bags. The obvious advantage of purchasing spat is the possibility of selling all of the stock in the third year. If the production assumptions are met, the oysters should be larger than 65 mm.

**TABLE V** Changes in production over the years

YEAR	Number of individuals being reared				
	Year 1	Year 2	Year 3	Year 4	Year 5
Year 1	500,000	475,000	451,250		
Year 2		500,000	475,000	451,250	
Year 3			500,000	475,000	451,250
Year 4				500,000	475,000
Year 5					500,000
Sale			(451,250)	(451,250)	(451,250)
Total stock	500,000	975,000	975,000	975,000	975,000

Table VI depicts the production cycle of an enterprise that collects spat. A production cycle based on spat collection is longer than the production cycle of an enterprise that buys spat. Savings on supplies justifies this approach.

**TABLE VI Production cycle**

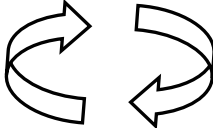
<p>BEGINNING OF CYCLE ⇒</p>	<p><b>FIRST SUMMER</b> 0 to 4 months - July to October</p> <p>SPAT (2 to 15 mm)</p>	<p><b>OVERWINTERING</b> November to April</p>
<p><b>FOURTH SUMMER</b> 38 months + September to June</p> <p>Marketing of cocktail and legal-sized oysters (70 mm and over)</p>		<p><b>SECOND SUMMER</b> 11 to 16 months - May to October</p> <p><b>JUVENILE OYSTERS</b> (15 to 45 mm)</p>
<p><b>OVERWINTERING</b> November to April</p>	<p><b>THIRD SUMMER</b> 23 to 28 months - May to October</p> <p><b>ADULT OYSTERS</b> Marketing of cocktail oysters (45 to 70 mm)</p>	<p><b>OVERWINTERING</b> November to April</p>



## **Workforce**

There are certain times during a production year when more workers are required. This is the case in spring and fall when the rearing equipment must be set out or stored for the winter. When the rearing cycle is over, additional staff has to be hired to carry out the harvesting activities. It is important to determine the number of workers accurately since that is a major operating expense for an enterprise. Unfortunately, there is no model for forecasting labour requirements. Each enterprise is unique and will have its own specific labour needs.

## **Equipment**

The rearing method and the scale of production are the parameters that have a direct impact on equipment needs. Equipment purchasing costs are the highest during the first years of production. Many materials specific to the different rearing methods are available, and there are a large number of suppliers. It is therefore recommended that the suppliers be consulted in order to obtain the best equipment at the best price. Supply and delivery times are other considerations that must be taken into account. It is important to plan the purchase of equipment properly because certain preparatory work takes time. For example, if oyster bags are purchased in the fall, they can be prepared during the winter, a season that is generally less busy. A section of this manual looks at oyster aquaculture equipment.

## CONCLUSION

The growing interest in shellfish aquaculture resulted in an influx of people to the offices of the New Brunswick Department of Agriculture, Fisheries and Aquaculture. However, the *Oysterculturist Manual* (Fergusson, 1984), which used to be distributed as a reference guide, no longer met the industry's needs. Editing it therefore seemed to be the logical next step, but once the project got under way, it became apparent that it would be impossible to edit the manual while incorporating all the new developments in the industry. The amount of information to be included was just too large.

The Department therefore decided to write a new manual adapted to today's needs. It should be noted, however, that this manual is destined to the same fate as the previous one. The concepts looked at in this manual, including biology and development of a production plan, will remain current for many years, but the rearing techniques, equipment, and operations will inevitably change over time.

## BIBLIOGRAPHY

ATLANTIC CANADA OPPORTUNITIES AGENCY. *Planning for Success – Your guide to preparing a business plan*, 24 pp.

THE CANADIAN INSTITUTE FOR RESEARCH AND REGIONAL DEVELOPMENT. *Cold Water Aquaculture in Atlantic Canada*, prepared by A.D. Boghen, 1995, 672 pp.

COMMUNICATIONS BRANCH, FISHERIES AND OCEANS. *Underwater World – Oyster*, prepared by K.D. Stewart, 1984, 6 pp.

ELNER, R.W., AND R.E. LAVOIE. "Predation on American Oyster (*Crassostrea virginica* Gmelin by American Lobsters (*Homarus americanus* Milne-Edwards), Rock Crabs (*Cancer irroratus* Say), and Mud Crabs (*Neopanope sayi* Smith)," *Journal of Shellfish Research*, Vol. 3, No. 2, 129-134, 1983.

DEPARTMENT OF FISHERIES OF NEW BRUNSWICK. *Oysterculturist Manual*, prepared by E. Ferguson, 1984, 81 pp.

KENNEDY, V.S., R.I.E. NEWELL, AND A.F. EBLE. *The Eastern Oyster: Crassostrea virginica*, Maryland Sea Grant College, 1996, 734 pp.

INSTITUT SCIENTIFIQUE ET TECHNIQUE DES PECHES MARITIMES. *La Conchyliculture française - Biologie de l'huître et de la moule*, prepared by L. Marteil, 1976, 319 pp.

MCGLADDERY, S.E., AND S.M. BOWER. *Synopsis of Infectious Diseases and Parasites of Commercially Exploited Shellfish: Malpeque Disease of Oysters*, 1999.

URL: [http://www.pac.dfo-mpo.gc.ca/sci/shelldis/pages/maldisoy\\_e.htm](http://www.pac.dfo-mpo.gc.ca/sci/shelldis/pages/maldisoy_e.htm)

FISHERIES RESEARCH BOARD OF CANADA. *Oyster Farming in the Maritimes*, prepared by J.C. Medcof, 1961, 158 pp.

DEPARTMENT OF FISHERIES AND AQUACULTURE OF NEW BRUNSWICK. *Practical Formulae, Calculations, and Glossary of Terms*, prepared by Washburn & Gillis Associates Ltd., 1995, 22 pp.

## APPENDIX I CONVERSION TO INTERNATIONAL SYSTEM

Distance		Equivalent in metres
1 millimetre	=	0.001 metre
1 centimetre	=	0.01 metre
1 decimetre	=	0.1 metre
1 metre	=	1 metre
1 decametre	=	10 metres
1 hectometre	=	100 metres
1 kilometre	=	1000 metres

### LENGTH

### AREA

1 kilometre	= 0.5396 nautical mile	1 acre	= 43,560 square feet
1 kilometre	= 0.62137 mile	1 acre	= 4,047 square metres
1 metre	= 1.0936 yard	1 hectare	= 2.471 acres
1 metre	= 3.2808 feet	1 hectare	= 107,640 square feet
1 metre	= 39.37 inches	1 hectare	= 10,000 square metres
1 mile	= 1.6093 kilometre		
1 mile	= 5,280 feet		
1 nautical mile	= 1.1515 mile		
1 foot	= 30.48 cm		
1 inch	= 25.4 mm		
1 yard	= 0.91 metre		

### MASS

### VOLUME

1 gram	= 0.0352 ounce	1 gallon (imp.) <sup>1</sup>	= 4.54 litres
1 pound	= 0.454 kg	1 litre	= 0.22 imp. gallon
1 pound	= 454 grams	1 litre	= 1 cubic decimetre
1 kilogram	= 2.2 pounds	1 litre	= 35.2 ounces (imp. fl.) <sup>2</sup>
1 kilogram	= 1,000 grams		
1 ounce	= 28.3 grams		
1 metric ton	= 1,000 kg		
1 metric ton	= 2,200 pounds		

\* <sup>1</sup> imp. = imperial

\* <sup>2</sup> imp. fl. = imperial fluid

## APPENDIX II HOW TO OPEN AN OYSTER

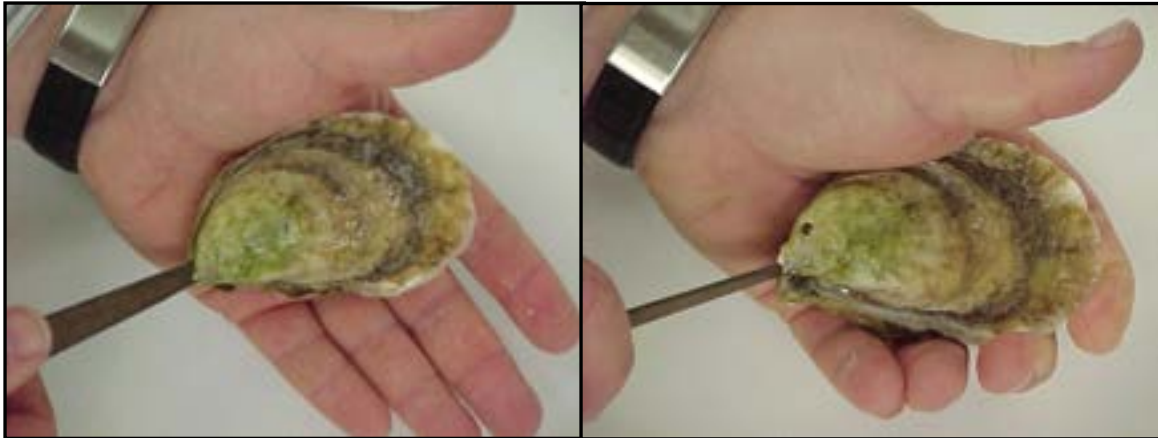

1. Insert the knife between the two shells at the hinge.

2. Twist the wrist to separate the shells.



3. Insert the knife into the oyster and cut the muscle.

4. Remove the top shell.

Note: To enjoy oysters raw, it is recommended that the surplus liquid be poured out. That way, you can fully appreciate the taste.

## APPENDIX III OVERWINTERING SPECIFICATIONS

### Lines

1. A line is 91.44 metres (300 feet) long.
2. Scope lines are 15.24 metres (50 feet) long.
3. Lines are spaced 7.62 metres (25 feet) apart.
4. Lines are anchored at the ends with metal screw anchors.
5. Struts are inserted every five bags [about 3 metres (10 feet)].
6. Struts are maintained on the bottom with 29.5-kg (65-lb.) weights.
7. Approximately one buoy is required per bag.

### Yield

1. Possibility of four lines per acre.
2. Possibility of 150 oyster bags suspended in a row on a line.
3. Estimated density of 1,000 oysters per bag, all sizes combined.
4. Yield of 600,000 overwintered oysters per acre.

**TABLE I**

ANNUAL PRODUCTION TARGET	250,000	500,000	1,000,000	1,500,000	2,000,000	5,000,000
Overwintering area required (in acres)	1.25	2.50	5.00	7.50	10.00	25.00

**NOTE 1: The production cycle is based on three years.**

**TABLE II**

ANNUAL PRODUCTION TARGET	250,000	500,000	1,000,000	1,500,000	2,000,000	5,000,000
Overwintering area required (in acres)	1.7	3.3	6.7	10.0	13.3	33.3

**NOTE 2: The production cycle is based on four years.**

## APPENDIX IV EQUIPMENT

Any developing industry needs specialized equipment to achieve its objectives. Oyster aquaculture is no exception. Since oyster bags came into use, a range of specialized products has made its appearance. Improvements are made to this equipment every day, and further adjustments will be required over the years. The following list shows the variety of equipment most commonly used today.

To give the bags their square shape, a bag press is required. Here are two examples: The photo on the left shows a commercially made bag press, while the photo on the right shows a home-made one that is just as effective.



To close the bags, the ends have to be cut in four different places. Oyster aquaculturists have developed a machine to do this: the bag cutter. The model below is one example, and several other types are available as well.



To bend the hooks, an iron pipe with a notch at one end is simple and effective.





Attaching the bags to the longlines is a process that takes time and energy. Oyster aquaculturists have developed a toggle-and-loop system that makes the job easier. The system was adapted from the technique used to moor lobster traps. The disc in the photo on the left is made of rubber, but there are discs made of PVC, vinyl, and other materials.



Boats:

A number of factors have an impact on the effectiveness of a boat or a work platform. Since most oyster aquaculture sites are located in shallow bays, it is recommended that boats with a shallow draft be used.



The size of a work platform varies according to the needs of the enterprise.



In France, oyster aquaculturists use scows to move around on their sites and transport their equipment. In New Brunswick, there is a growing interest in flat-bottom boats, but the types of construction are as varied as they are numerous. The two examples below show two models made of fiberglass.





To place large quantities of oysters in bags, a piece of equipment made in Europe can be ordered from different French companies. It is called a bagging and weighing machine. The oysters are poured into a hopper at the lower end of a conveyor belt, which carries them to the bag opening. Once the set weight has been reached, the conveyor stops automatically.

